

TX-14S3TC / TC-14S3RC Service Manual

Safety

Specifications

Parts List

Service
Information

Adjustments

Self Check

Service Hints

Mechanical
View

Disassembly

Location of
Controls

Waveforms

Block Diagrams

Schematic Diagrams

PCB Views

Service Support

Service and repair of this product is supported by Panasonic's LUCI interface.

This interface provides a link between the TV and a standard PC to allow a number of diagnostic and control functions to be performed.

For more details contact your local Panasonic company.

BACK

EXIT

Video / Audio

Control



BACK

E - PCB

Y - PCB



BACK

E - Schematic

Y - Schematic



BACK

Service Manual



Colour Television TX-14S3TC TC-14S3RC Z-7 Chassis

SPECIFICATIONS

Power Source :	220-240V AC, 50Hz	
Power Consumption :	33W	
Standby Power Consumption :	1W	
Aerial Impedance :	75Ω unbalanced, Coaxial Type	
Receiving System :	PAL-BG, H, PAL 525/60, NTSC (AV Only)	
Receiving Channels :	VHF E2 - E12 VHF H1 - H2 (ITALY) VHF A - H (ITALY) UHF E21 - E69 CATV (S01 - S05) CATV S1 - S10 (M1 - M10) CATV S11 - S20 (U1 - U10) CATV S21 - S41 (HYPERBAND)	
Intermediate Frequency :	Video 38.9 MHz Sound 33.4 MHz, 33.16 MHz Colour 34.47 MHz	
Video / Audio Terminals :		
AV1 IN	Video (21 pin)	1V p-p 75Ω
	Audio (21 pin)	500mV rms 10kΩ
	RGB (21 pin)	
AV1 OUT	Video (21 pin)	1V p-p 75Ω
	Audio (21 pin)	500mV rms 1kΩ
RCA IN	Video	1V p-p 75Ω
RCA IN	Audio	500mV rms, 10KΩ
High Voltage :	23kV + 0.7kV / - 1kV (zero beam current)	
Picture Tube :	A34EAC01X13 34 cm	
Audio Output : Speaker	6 W (Music Power) 8 Ω Impedance	
Headphones	8 Ω Impedance	
Accessories supplied :	Remote Control 2 x R6 (UM3) Batteries	
Dimensions :	Height :	364 mm
	Width :	389 mm
	Depth :	384 mm
Net Weight :	10kg	

Specifications are subject to change without notice.
Weight and dimensions shown are approximate.

TECHNISCHE DATEN

Netzspannung :	220-240V AC, 50Hz	
Leistungsaufnahme :	33W	
Standby Leistungsaufnahme :	1W	
Antennenimpedanz :	75Ω asymmetrisch, Koaxial- Typ	
Empfangssystem :	PAL-BG, H, PAL 525/60, NTSC (nur AV Eingang)	
Empfangsbereiche :	VHF E2 - E12 VHF H1 - H2 (ITALY) VHF A - H (ITALY) UHF E21 - E69 CATV (S01 - S05) CATV S1 - S10 (M1 - M10) CATV S11 - S20 (U1 - U10) CATV S21 - S41 (HYPERBAND)	
Zwischenfrequenz :	Video 38.9 MHz Sound 33.4 MHz, 33.16 MHz Colour 34.47 MHz	
Video / Audio Anschlüsse :		
AV1 EINGANG	Video (21 pin)	1V p-p 75Ω
	Audio (21 pin)	500mV rms 10kΩ
	RGB (21 pin)	
AV1 AUSGANG	Video (21 pin)	1V p-p 75Ω
	Audio (21 pin)	500mV rms 1kΩ
RCA EINGANG	Video	1V p-p 75Ω
RCA EINGANG	Audio	500mV rms, 10KΩ
Hochspannung: (bei Nullstrahlstrom)	23kV + 0.7kV / - 1kV	
Bildrohre :	A34EAC01X13 34 cm	
Ton Ausgangsleistung : Lautsprecher	6 W (Musikleistung) 8 Ω Impedanz	
Kopfhörer	8 Ω Impedanz	
Mittel. Zubehör	Fernbedienung 2 x R6 (UM3) Batterien	
Abmessungen :	Höhe :	364 mm
	Breite :	389 mm
	Tiefe :	384 mm
Gewicht :	10kg	

Änderungen der technischen Daten vorbehalten.
Gewichte und Abmessungen sind Näherungsangaben.

CONTENTS

- SAFETY PRECAUTIONS
- SERVICE HINTS
- ADJUSTMENT PROCEDURE
- ALIGNMENT SETTINGS
- SELF CHECK
- WAVEFORM PATTERN TABLE
- BLOCK DIAGRAMS
- PARTS LOCATION
- REPLACEMENT PARTS LIST
- CONDUCTOR VIEWS
- SCHEMATIC DIAGRAMS

SAFETY PRECAUTIONS

GENERAL GUIDE LINES

1. It is advisable to insert an isolation transformer in the AC supply before servicing a hot chassis.
2. When servicing, observe the original lead dress in the high voltage circuits. If a short circuit is found, replace all parts which have been overheated or damaged by the short circuit.
3. After servicing, see that all the protective devices such as insulation barriers, insulation papers, shields and isolation R—C combinations are correctly installed.
4. When the receiver is not being used for a long period of time, unplug the power cord from the AC outlet.
5. Potentials as high as 24kV are present when this receiver is in operation. Operation of the receiver without the rear cover involves the danger of a shock hazard from the receiver power supply. Servicing should not be attempted by anyone who is not familiar with the precautions necessary when working on high voltage equipment. Always discharge the anode of the picture to the chassis before handling the tube.
6. After servicing make the following leakage current checks to prevent the customer from being exposed to shock hazards.

LEAKAGE CURRENT COLD CHECK

1. Unplug the AC cord and connect a jumper between the two prongs of the plug.
2. Turn on the receiver's power switch.
3. Measure the resistance value with an ohmmeter, between the jumpered AC plug and each exposed metallic cabinet part on the receiver, such as screw heads, aerials, connectors, control shafts etc. When the exposed metallic part has a return path to the chassis the reading should be between 4M ohm and 20M ohm. When the exposed metal does not have a return path to the chassis the reading must be infinite.

INHALT

- SICHERHEITSVORKEHRUNGEN
- SERVICE HINWEISE
- ABGLEICH
- ABGLEICHTABELLE
- SELF CHECK
- SIGNALE TABELLE
- SCHALTBILD BLOCK
- EXPLOSIONSZEICHNUNG
- ERSATZTEILLISTE
- ANSICHT DER LEITERBAHNEN
- SCHALTBILD SCHEMA

SICHERHEITSVORKEHRUNGEN

ALLGEMEINE RICHTLINIEN

1. Es ist empfehlenswert einen Trenntransformator in die Stromversorgung zu schalten, bevor Reparaturen an einem Gerät vorgenommen werden, dessen Chassis unter Spannung steht.
2. Bei der Durchführung von Servicearbeiten dürfen die ursprünglichen Kabelanschlüsse nicht vertauscht werden. Dies gilt insbesondere für die Anschlüsse im Hochspannungsteil. Hat sich ein Kurzschluß ereignet, dann sind alle Teile, an denen Spuren von Überhitzung sichtbar sind, auszuwechseln.
3. Nach Beenden der Servicearbeiten ist sicherzustellen, daß alle Sicherheitsvorrichtungen, wie Isolationsstege, Isolationspapiere, Abschirmungen und Isolations—R—C— Glieder wieder richtig eingesetzt sind.
4. Wenn der Fernseher während längerer Zeit nicht in Betrieb gesetzt wird, sollte der Netzstecker aus der Netzsteckdose gezogen werden.
5. Im Betrieb sind Spannungen bis zu 24kV in diesem Gerät vorhanden. Die Inbetriebnahme des Fernsehers ohne aufgesetzte Rückwand bringt die Gefahr eines elektrischen Schlages von der Fernseher — Stromversorgung mit sich. Servicearbeiten sollten daher auch nie durch Personen versucht werden, die nicht in vollem Umfang mit den Sicherheitsvorkehrungen beim Umgang mit Hochspannungsgeräten vertraut sind. Vor der Handhabung mit der Bildröhre ist die Anode der Bildröhre immer an dem Empfängerchassis zu entladen.
6. Nach Beenden der Servicearbeiten sind die folgenden Kriechstrom—Prüfungen durchzuführen, um den Kunden vor der Gefahr eines elektrischen Schlages zu schützen.

MESSUNG DES ISOLATIONSWIDERSTANDES IM ABGESCHALTETEN ZUSTAND

1. Den Netzstecker aus der Netzsteckdose ziehen und die beiden Steckerstifte kurzschließen.
2. Den Geräteschalter des Fernsehgerätes einschalten.
3. Mit einem Ohmmeter den Widerstandswert zwischen dem überbrückten Netzkabelstecker und jenem zugänglichen Metallteil am Gehäuse des Fernsehgerätes, wie Schraubenköpfe, Antennen, Achsen der Regler, Griffassungen usw. messen. Wenn ein zugängliches Metallteil keine Rückleitung zum Chassis hat, muß die Anzeige unendlich betragen.

LEAKAGE CURRENT HOT CHECK

1. Plug the AC cord directly into the AC outlet. Do not use an isolation transformer for this check.
2. Connect a 2kΩ 10W resistor in series with an exposed metallic part on the receiver and an earth such as a water pipe.
3. Use an AC voltmeter with high impedance to measure the potential across the resistor.
4. Check each exposed Metallic part and check the voltage at each point.
5. Reverse the AC plug at the outlet and repeat each of the above measurements.
6. The potential at any point should not exceed 1.4 Vrms. In case a measurement is outside the limits specified, there is a possibility of a shock hazard, and the receiver should be repaired and rechecked before it is returned to the customer.

MESSUNG DES KRIECHSTROMS IM EINGESCHALTETEN ZUSTAND

1. Den Netzstecker direkt in eine Netsteckdose stecken. Für diese Messung keinen Trenntransformator verwenden.
2. Einen 2k Ω / 10W–Widerstand in Serie mit einem von außen zugänglichen Metallteil am Fernsehgerät und einer guten, Erdung z.B Wasserleitung, anschließen.
3. Ein Wechselstrom–Voltmeter mit einem Meßbereich von 1000 Ohm.Volt oder größer verwenden, um die Spannung über den Widerstand zu messen.
4. Jedes zugängliche Metallteil prüfen, und an jedem Punkt dies Spannung messen.
5. Den Netzstecker umgekehrt in die Steckdose stecken und jede der obigen Messungen wiederholen.
6. Die Spannung darf an keinem der Punkte 1.4V eff. überschreiten. Wird dieser Wert nicht eingehalten, besteht die Gefahr eines elektrischen Schlages, und das Fernsehgerät sollte daher repariert und nachgeprüft werden, bevor es an den Kunden zurückgegeben wird.

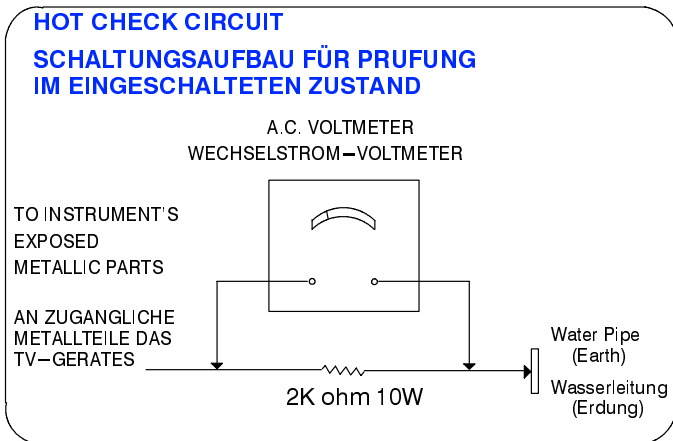

Fig.1.
Abb.1.

X-RADIATION WARNING

1. The potential sources of X-Radiation in TV sets are the high voltage section and the picture tube.
2. When using a picture tube test jig for service ensure that the jig is capable of handling 24kV without causing X-Radiation.

NOTE : It is important to use an accurate periodically calibrated high voltage meter

1. Set the brightness to minimum.
2. Measure the high voltage. The meter should indicate 23kV + 0.7 / - 1kV if the meter indication is out of tolerance, immediate service and correction is required to prevent the possibility of premature component failure.
3. To prevent any X-Radiation possibility, it is essential to use the specified tube.

RÖNTGENSTRAHLUNG ACHTUNG :

1. Potentielle Quellen von Röntgenstrahlung in Fernsehgeräten sind das Hochspannungsteil und die Bildröhre.
2. Bei Verwendung eines Bildröhren-Prüfgerätes für den Service ist sicherzustellen, daß es für die Belastung von 24kV geeignet ist, ohne daß eine Röntgenstrahlung verursacht wird.

ANMERKUNG : Es ist wichtig, daß ein präzises, regelmäßig geprüftes Voltmeter verwendet wird.

1. Helligkeit auf Minimum stellen.
2. Die Hochspannung messen. Die Anzeige des Instrumentes sollte 23kV + 0.7 / - 1kV Falls die Anzeige diese Toleranzgrenzen überschreitet, ist die sofortige Behebung nötig, um die Möglichkeit vorzeitigen Komponentenausfalls zu verhüten.
3. Um die Möglichkeit von Röntgenstrahlung zu begrenzen, ist es wichtig, daß nur die vorgeschriebene Bildröhre verwendet wird.

SERVICE HINTS

HOW TO REMOVE THE REAR COVER

1. Remove the 5 screws (A) as shown in **Fig.2/Fig.3.**

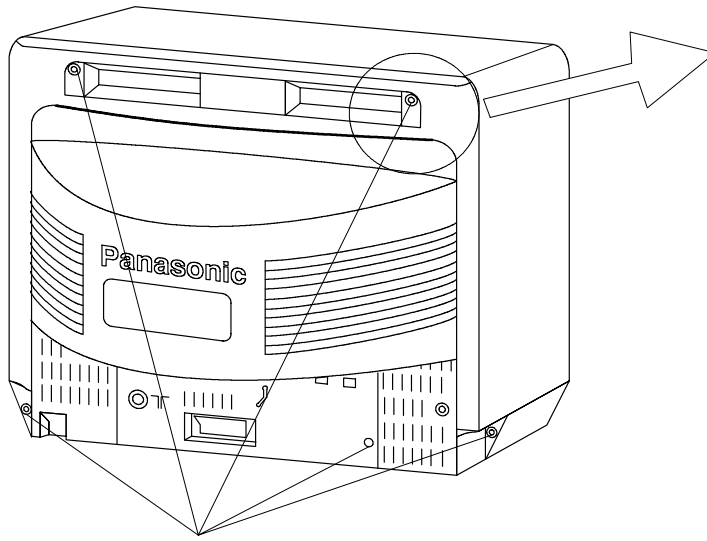

SCREWS A
SCHRAUBEN A

Fig. 2.
Abb. 2.

SERVICE HINWEISE

ENTFERNEN DER GERÄTERÜCKWAND

1. Die 5 Schrauben (A) entfernen, siehe **Abb.2/Abb.3.**

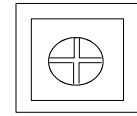

SCREW
SCHRAUBEN

Fig. 3.
Abb. 3.

LOCATION OF CONTROLS

LAGE DER EINSTELLREGLER

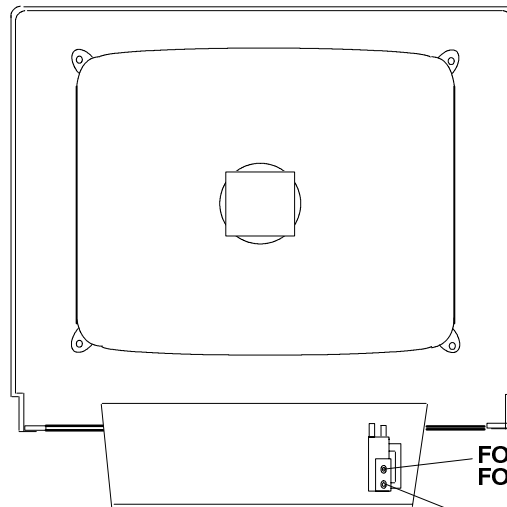

E PC.B.

Fig. 4.
Abb. 4.

FOCUS
FOKUSREGLER

SCREEN
SCHIRMGITTERREGLER

ADJUSTMENTS

ITEM/PREPARATION	ADJUSTMENT PROCEDURE
<p>B VOLTAGE</p> <p>1. Operate the TV set.</p> <p>2. Set controls :</p> <p>Bright minimum</p> <p>Sub Bright minimum</p> <p>Volume minimum</p> <p>Beam Current Zero</p>	<p>1. Confirm the indicated test points for the specified voltage.</p> <p>TPE 1: 9V ± 1V</p> <p>TPE 2: 5V ± 0.3V</p> <p>TPE 3: 12V ± 1V</p> <p>TPE 4: 30V ± 2.5V</p> <p>TPE 5: 5V ± 0.3V</p> <p>TPE 6: 9V ± 0.3V</p> <p>TPE 9: 22V ± 1V</p> <p>TPE 10: 185V ± 10V</p> <p>TPE 11: 12V ± 1V</p> <p>TPE 12: 12V ± 1.5V</p> <p>TPE 13: 125V ± 1.5V</p> <p>TPE 14: 8V ± 1V</p> <p>TPE 18: 8V ± 1V</p> <p>TPE 19: 31V ± 1.5V</p>

ABGLEICH

VORBEREITUNG	ABGLEICH
<p>B VOLTAGE</p> <p>1. TV einschalten</p> <p>2. Die Regler wie folgt einstellen:</p> <p>Helligkeit minimum.</p> <p>Grundhelligkeitsregler minimum.</p> <p>Kontrast minimum</p> <p>Strahlstrom Null</p>	<p>1. Die Messungen an den Testpunkten sollen folgende Betriebsspannungsergebnisse ergeben.</p> <p>TPE 1: 9V ± 1V</p> <p>TPE 2: 5V ± 0.3V</p> <p>TPE 3: 12V ± 1V</p> <p>TPE 4: 30V ± 2.5V</p> <p>TPE 5: 5V ± 0.3V</p> <p>TPE 6: 9V ± 0.3V</p> <p>TPE 9: 22V ± 1V</p> <p>TPE 10: 185V ± 10V</p> <p>TPE 11: 12V ± 1V</p> <p>TPE 12: 12V ± 1.5V</p> <p>TPE 13: 125V ± 1.5V</p> <p>TPE 14: 8V ± 1V</p> <p>TPE 18: 8V ± 1V</p> <p>TPE 19: 31V ± 1.5V</p>

ALIGNMENT SETTINGS

1. Select program position 60 and set the sharpness to minimum.
2. Press the Off Timer button on the remote control and at the same time press the V (down) button on the customer controls at the front of the TV, this will place the TV into Service Mode.
3. Press the \wedge / \vee buttons to step up / down through the functions.
4. Press the + / - buttons to alter the function values.
5. Press the STORE button after each adjustment has been made to store the required values.
6. To exit Service Mode press the Normalisation button.

NOTE :

The figures used below are nominal and used for representative purposes only

Alignment Function		Settings / Special Features
1. Vertical amplitude	V–Amp 27	Optimum setting
2. Vertical position	V–Pos 03	Optimum setting
3. Horizontal centre	H–Ctr 07	Optimum setting
4. Red cutoff	R–Cut 186	Optimum setting
5. Green cutoff	G–Cut 220	Optimum setting
6. Blue cutoff	B–Cut 213	Optimum setting
7. Red drive	R–Drv 46	Optimum setting
8. Blue drive	B–Drv 36	Optimum setting
9. AGC	AGC 33	Optimum setting
10. Sub contrast	S–Con 33	Optimum setting
11. Sub colour	S–Col 39	Optimum setting
12. Sub bright	S–Bri 40	Optimum setting

ABGLEICHTABELLE

1. Programmplatz 60 wählen und Schärfe auf Minimum stellen.
2. Taste 'Ausschalt-Timer' auf der Fernbedienung und gleichzeitig die Taste 'V' (ab) auf dem Bedienungsfeld vorn am Fernsehgerät drücken, um das Gerät in den Service-Modus zu versetzen.
3. Die einzelnen Funktionen mit Hilfe der \wedge / \vee Taste anwählen.
4. Mit der + / - Taste die Werte der einzelnen Funktionen ändern.
5. Nach jeder Einstellung die Taste STR auf der Fernbedienung oder am Bedienfeld drücken, um die geänderten Werte abzuspeichern.
6. Zum Verlassen des Service-Modus die "N"-Taste auf der Fernbedienung drücken

ANMERKUNG :

Die angegebenen Werte sind Mittelwerte und Können individuell nach oben oder unten nach dem korrekten Abgleich abweichen.

Abgleichfunktion		Einstellung/Besondere Merkmale
1. Vertikale amplitude	V-Amp 27	Optimale Einstellung
2. Vertikale position	V-Pos 03	Optimale Einstellung
3. Horizontale centre	H-Ctr 07	Optimale Einstellung
4. Red cutoff	R-Cut 186	Optimale Einstellung
5. Green cutoff	G-Cut 220	Optimale Einstellung
6. Blue cutoff	B-Cut 213	Optimale Einstellung
7. Red drive	R-Drv 46	Optimale Einstellung
8. Blue drive	B-Drv 36	Optimale Einstellung
9. AGC	AGC 33	Optimale Einstellung
10. Sub contrast	S-Con 33	Optimale Einstellung
11. Sub colour	S-Col 39	Optimale Einstellung
12. Sub bright	S-Bri 40	Optimale Einstellung

SELF CHECK

Self check is used to automatically check the Bus Lines Hexadecimal code of the TV set.

To access the Self Check mode press the Status button on the Remote Control, followed by the V button on the customer controls at the front of the TV, and the screen will show: –

When exiting Self Check the customer settings will return to factory settings.

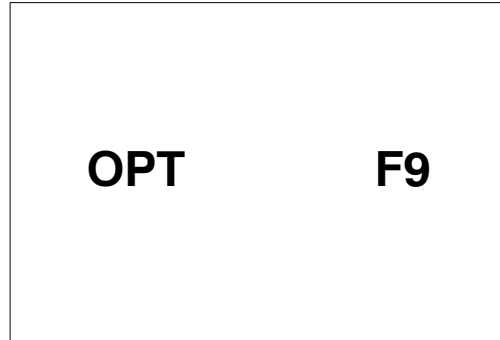



SELF CHECK

1) Die Selbstdiagnose dient zum automatischen Prüfen der Bus–Leitungen, sowie des Hexadezimalcodes des Gerätes. Zum Aufrufen der Selbstprüfungsfunktion die Statustaste auf der Fernbedienung und dann die Taste 'V' auf dem Bedienungsfield vorn am Fernsehgerät drücken, worauf der entsprechende Bildschirm erscheint.: –

2) Nach der Selbstdiagnose wird das Gerät automatisch auf sämtliche werksseitigen Standardeinstellungen zurückgesetzt: –

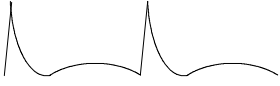
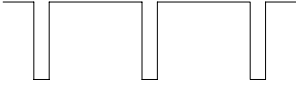
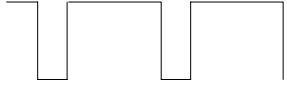
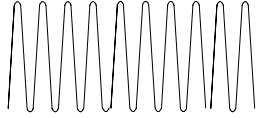
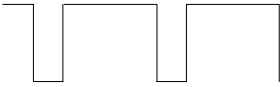

WAVEFORM PATTERN TABLE SIGNAL TABELLE

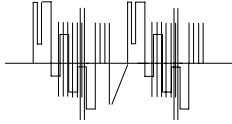
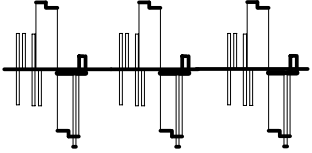
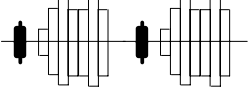
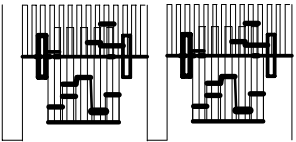
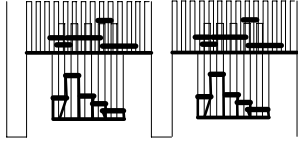
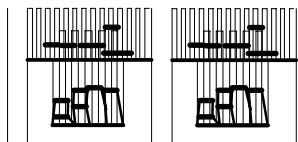
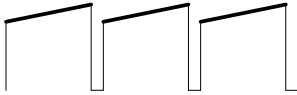
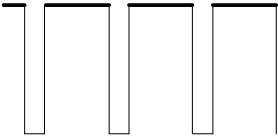
<p style="text-align: center;">Vert Out IC IN</p>  <p style="text-align: center;">IC451 pin 4</p>	<p style="text-align: center;">H.Sync</p>  <p style="text-align: center;">IC601 pin 11</p>	<p style="text-align: center;">SCL</p>  <p style="text-align: center;">IC1201 pin 3</p>	<p style="text-align: center;">H – OSC</p>  <p style="text-align: center;">IC 601 pin 15</p>
<p style="text-align: center;">SDA</p>  <p style="text-align: center;">IC601 pin 14</p>	<p style="text-align: center;">Slow Switch</p>  <p style="text-align: center;">IC1201 pin 46</p>	<p style="text-align: center;">'BY' Out</p>  <p style="text-align: center;">IC601 pin 41</p>	<p style="text-align: center;">'RY' Out</p>  <p style="text-align: center;">IC601 pin 43</p>
<p style="text-align: center;">IF VO</p>  <p style="text-align: center;">IC601 pin 52</p>	<p style="text-align: center;">B Out</p>  <p style="text-align: center;">TPE15</p>	<p style="text-align: center;">G Out</p>  <p style="text-align: center;">TPE16</p>	<p style="text-align: center;">R Out</p>  <p style="text-align: center;">TPE17</p>
<p style="text-align: center;">Vert Drive</p>  <p style="text-align: center;">IC451 pin 2</p>	<p style="text-align: center;">H. Out</p>  <p style="text-align: center;">IC601 pin 13</p>		

VIDEO / AUDIO SIGNAL BLOCK DIAGRAM BILD SIGNAL / TON SIGNAL BLOCKSCHEMA

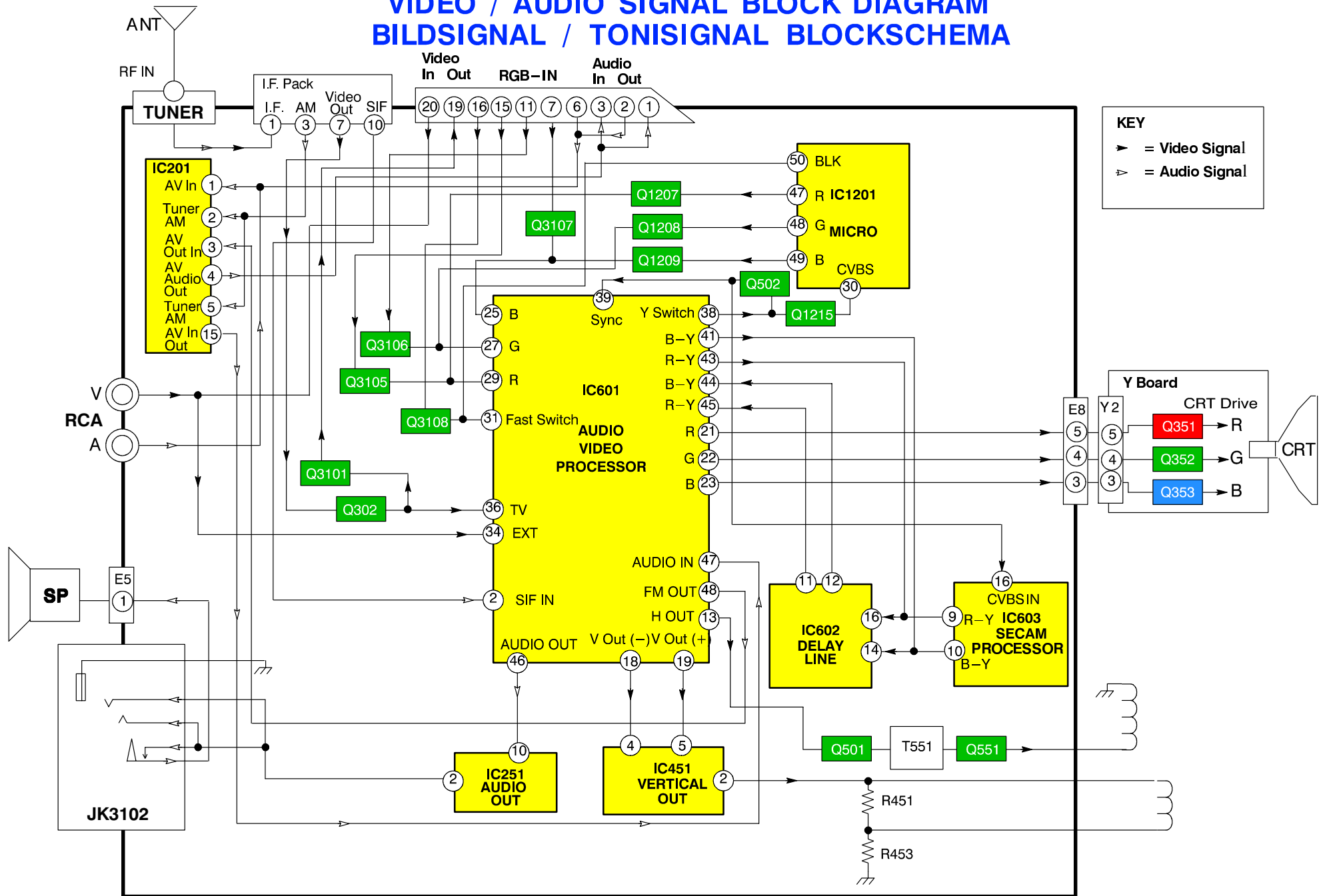

POWER SUPPLY BLOCK DIAGRAM STROMVERSORGUNGS BLOCKSCHEMA

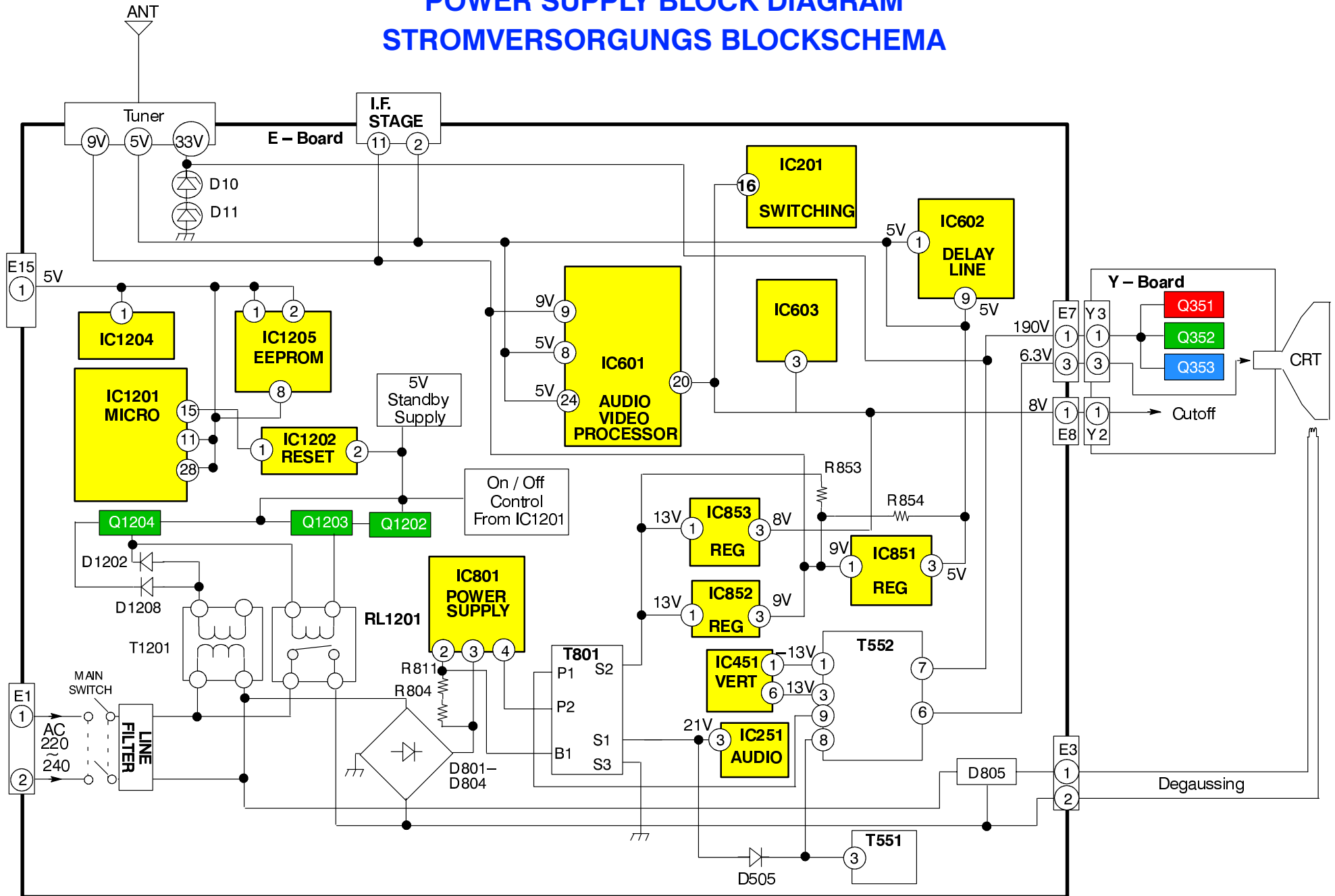

CONTROL BLOCK DIAGRAM

KONTROLL BLOCKSCHEMA

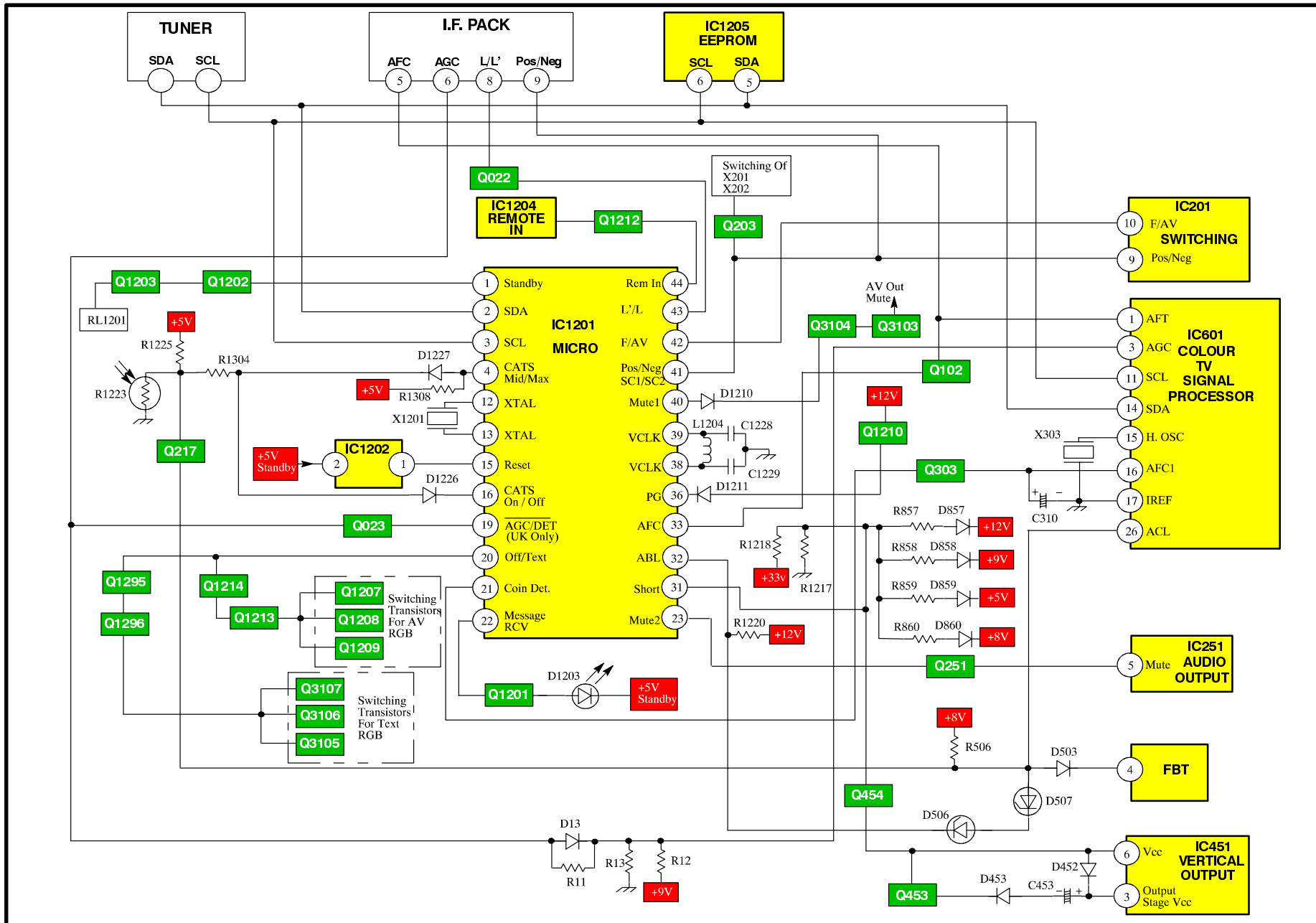

PARTS LOCATION

NOTE :

The numbers on the exploded view below refer to the miscellaneous section of the Replacement Parts List.

EXPLOSIONSZEICHNUNG

Anmerking :

Die Nummer auf den mechanischen Teilen zeigt die Bezugsnummer der Ersatzteilliste an.

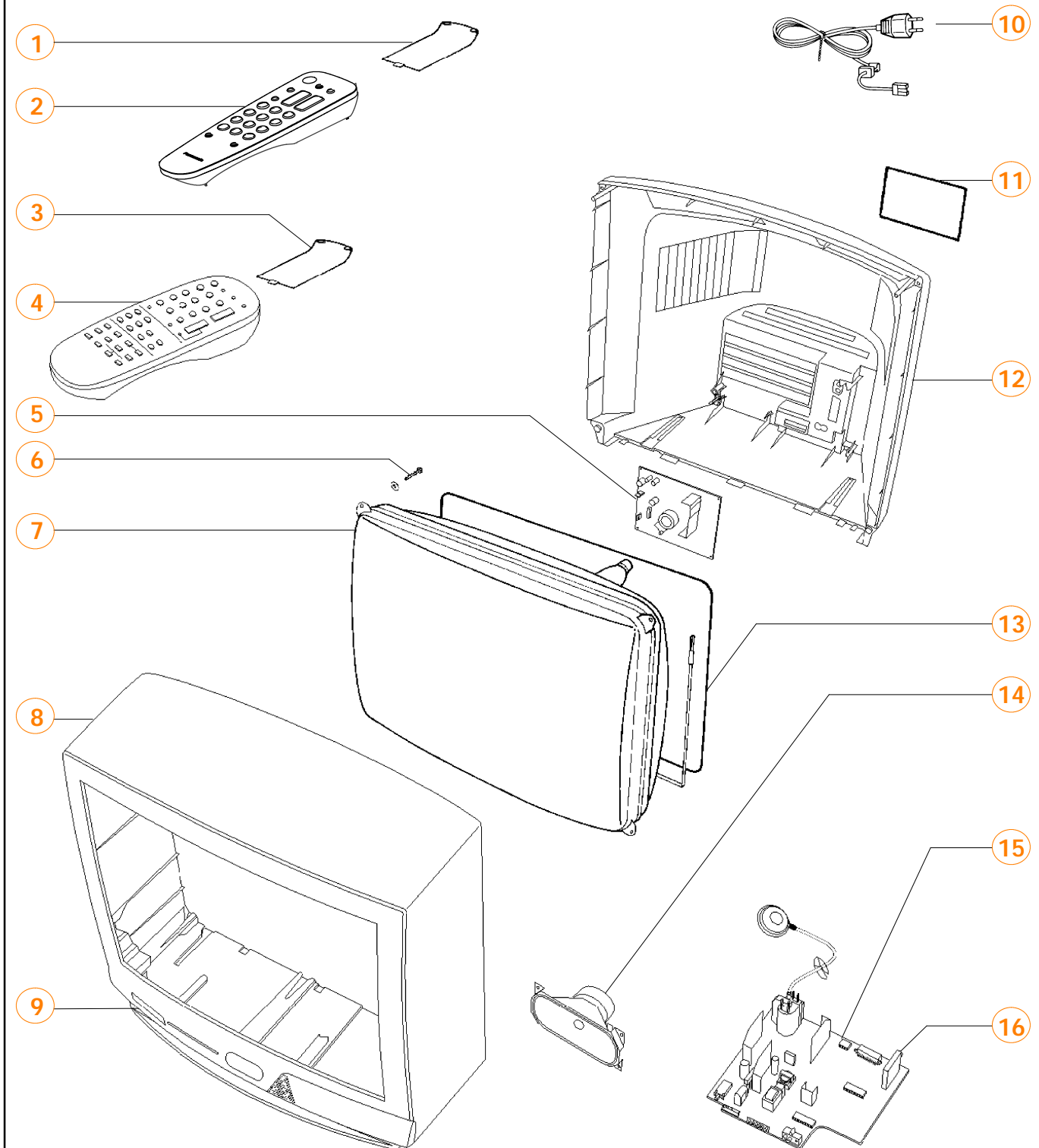

REPLACEMENT PARTS LIST

Important Safety Notice

Components identified by Δ mark have special characteristics important for safety. When replacing any of these components, use only manufacturer's specified parts.

PARTS COMMON TO TX-14S3TC AND TC-14S3RC

Ref No.	Part No.	Description
MISCELLANEOUS COMPONENTS		
1)	*****	REFER TO DIFFERENCE LIST
2)	*****	REFER TO DIFFERENCE LIST
3)	*****	REFER TO DIFFERENCE LIST
4)	*****	REFER TO DIFFERENCE LIST
5)	TNP8EY011AD	Y P.C.B. Δ
6)	THE492-4	CRT FIXING SCREW
7)	A34EAC01X13	C.R.T. Δ
8)	TKY8E028	CABINET Δ
9)	TBX8E018	POWER BUTTON
10)	TSX8E0020	POWER CORD Δ
11)	*****	REFER TO DIFFERENCE LIST
12)	TKU8E00223	BACK COVER Δ
13)	TLK8E05134	DEGAUSS COIL Δ
14)	EASG9D541 B2	SPEAKER
15)	*****	REFER TO DIFFERENCE LIST
16)	ENV57D13G3	TUNER Δ
	TBM153023	PANASONIC BADGE
	TBX8E029-1	5 KEY BLOCK
	TKP8E1147	LID
	TPC8E4617	OUTER CARTON
	TPD8E578	TOP CUSHION
	TPD8E579	BOTTOM CUSHION
	TMW8E015-2	LED HOLDER
	TQB8E2281	INST BOOK Δ
	TSA120026	MONOPOLE ANTENNA
	UM-3DEP-2P	BATTERY
	31221212478	FIX CLIP
INTEGRATED CIRCUITS		
IC251	LA4265	AUDIO OUTPUT
IC451	LA7840	VERTICAL OUTPUT
IC601	M52778SP	AUDIO VIDEO PROCESSOR
IC602	U3665M-MDP	DELAY LINE
IC801	STR58041A	POWER SUPPLY
IC851	L78M05MRB	5V REGULATOR
IC852	L78M09MRB	9V REGULATOR
IC853	AN78M08LB	8V REGULATOR
IC1202	MN1280R	RESET
IC1204	RPM-637CBRS	RECEIVER
CAPACITORS		
C010	ECUV1H103KBX	S.M.CAP 50V 10nF
C011	ECA1CM100GB	ELECT 16V 10pF
C012	ECUV1H103KBX	S.M.CAP 50V 10nF
C014	ECUV1H080DCX	S.M.CAP 50V 80pF
C015	ECA1HM330B	ELECT 50V 33pF
C019	ECUV1H103KBX	S.M.CAP 50V 10nF
C020	ECA1HM010GB	ELECT 50V 1pF
C022	ECUV1H150JCX	S.M.CAP 50V 15pF
C023	ECUV1H150JCX	S.M.CAP 50V 15pF
C102	ECUV1H101JCX	S.M.CAP 50V 100pF
C103	ECUV1H103KBX	S.M.CAP 50V 10nF
C105	ECUV1H103KBX	S.M.CAP 50V 10nF
C107	ECA1HMR22GB	ELECT 50V 0.22 μ F

ERSATZTEILLISTE

Wichtiger Sicherheitshinweis

Teile, die mit einem Hinweis Δ gekennzeichnet sind, sind wichtig für die Sicherheit. Sollte ein Auswechsein erforderlich sein, sind unbedingt Originalteile einzusetzen.

Ref No.	Part No.	Description
C108	ECUV1H103KBX	S.M.CAP 50V 10nF
C109	ECA1HMR47GB	ELECT 50V 0.47 μ F
C110	ECA1HM0R1B	ELECT 50V 0.1 μ F
C111	ECUV1H103KBW	S.M.CAP 50V 10nF
C112	ECA1HMR47GB	ELECT 50V 0.47 μ F
C113	ECUV1H103KBX	S.M.CAP 50V 10nF
C114	ECA1HM010GB	ELECT 50V 1pF
C116	ECUV1H104KBX	S.M.CAP 50V 100nF
C201	ECUV1H272KBX	S.M.CAP 50V 2.7nF
C203	ECUV1H220JCX	S.M.CAP 50V 22pF
C204	ECUV1H220JCX	S.M.CAP 50V 22pF
C207	ECEA1CN100	ELECT 16V 10 μ F
C208	ECA1CM100GB	ELECT 16V 10pF
C251	ECA1EM471GB	ELECT 25V 470pF
C252	ECA1HM010GB	ELECT 50V 1pF
C253	ECA1EM470GB	ELECT 25V 47pF
C254	ECUV1H272JCX	S.M.CAP 50V 2.7nF
C255	ECQB1H104J	FILM 50V 100nF
C256	ECQM1H224J	FILM 50V 220nF
C257	ECQM1H474J	FILM 50V 470nF
C258	ECA1EM101GB	ELECT 25V 1 μ F
C260	ECA1EM102GB	ELECT 25V 1nF
C261	ECUV1H471JCX	S.M.CAP 50V 470pF
C262	ECA1HM101GB	ELECT 50V 100pF
C301	ECA1HM101GB	ELECT 50V 100pF
C302	ECUV1H104ZFX	S.M.CAP 50V 100nF
C303	ECA1CM471GB	ELECT 16V 470pF
C304	ECUV1H104ZFX	S.M.CAP 50V 100nF
C305	ECA1HM101GB	ELECT 50V 100pF
C307	ECA1HM101GB	ELECT 50V 100pF
C308	ECUV1H104ZFW	S.M.CAP 50V 100nF
C309	ECUV1H103KBX	S.M.CAP 50V 10nF
C310	ECA1HM010GB	ELECT 50V 1pF
C311	ECUV1H104ZFX	S.M.CAP 50V 100nF
C312	ECUV1H104ZFX	S.M.CAP 50V 100nF
C313	ECUV1H104ZFX	S.M.CAP 50V 100nF
C314	ECEA1HNR47UB	ELECT 50V 0.47 μ F
C315	ECEA1HN2R2UB	ELECT 50V 2.2 μ F
C316	ECA1HM101GB	ELECT 50V 100pF
C317	ECA1HM101GB	ELECT 50V 100pF
C318	ECEA1HNR47UB	ELECT 50V 0.47 μ F
C319	ECUV1H104ZFX	S.M.CAP 50V 100nF
C351	ECUV1H151JCX	S.M.CAP 50V 150pF
C352	ECUV1H151JCX	S.M.CAP 50V 150pF
C353	ECUV1H181JCX	S.M.CAP 50V 180pF
C355	ECKC3D152J	CERAMIC 2KV 1.5nF Δ
C357	ECKC2H152J	CERAMIC 500V 1.5nF Δ
C362	ECUV1H102ZFX	S.M.CAP 50V 1nF
C368	ECEA2EU010	ELECT 250V 1 μ F
C370	ECA1CM220GB	ELECT 16V 22 μ F
C371	ECA1CM221GB	ELECT 16V 220pF
C401	ECUV1H223KBX	S.M.CAP 50V 22nF
C402	ECUV1H472KBX	S.M.CAP 50V 4.7nF
C403	ECA1HM010GB	ELECT 50V 1pF
C404	ECUV1H103ZFX	S.M.CAP 50V 10nF
C452	ECQM1H274J	FILM 50V 270nF
C453	ECEA1HU101	ELECT 50V 100 μ F
C454	ECA1HM2R2GB	ELECT 50V 2.2 μ F
C457	ECQM1H394J	FILM 50V 390nF
C461	ECUV1H100CCX	S.M.CAP 50V 10pF
C501	ECA1HM010GB	ELECT 50V 1pF

Ref No.	Part No.	Description			
C502	ECUV1H223KBX	S.M.CAP	50V	22nF	
C503	ECUV1H391JCX	S.M.CAP	50V	390pF	
C504	ECEA1HN010UB	ELECT	50V	1μF	
C505	ECUV1H331JCX	S.M.CAP	50V	330pF	
C506	ECQM1273KZW	FILM	100V	27nF	
C507	ECA1HM100GB	ELECT	50V	10pF	
C541	ECEA1EN4R7UB	ELECT	25V	4.7μF	
C550	ECA1VM471GB	ELECT	35V	470pF	
C551	ECWH12H822J	CERAMIC	1250V	8.2nF	△
C552	ECQE6104K	FILM	600V	100nF	△
C554	ECKC3D681J	CERAMIC	2KV	680pF	△
C557	ECWF2H474J	FILM	500V	470nF	△
C558	ECEA2CG010	ELECT	160V	1μF	
C559	ECKC2H471J	CERAMIC	500V	470pF	△
C560	ECKC2H471J	CERAMIC	500V	470pF	△
C561	ECEA2EU100	ELECT	250V	10μF	
C562	ECKC2H471J	CERAMIC	500V	470pF	△
C563	ECA1VM471GB	ELECT	35V	470pF	
C564	ECA1CM471GB	ELECT	16V	470pF	
C565	ECA1VM471GB	ELECT	35V	470pF	
C566	ECKC2H471J	CERAMIC	500V	470pF	△
C567	ECA1VM471GB	ELECT	35V	470pF	
C601	ECUV1H473KBX	S.M.CAP	50V	47nF	
C602	ECUV1H153KBX	S.M.CAP	50V	15nF	
C603	ECA1HM010GB	ELECT	50V	1pF	
C605	ECUV1H150JCX	S.M.CAP	50V	15pF	
C606	ECUV1H104ZFX	S.M.CAP	50V	100nF	
C607	ECUV1H104ZFX	S.M.CAP	50V	100nF	
C608	ECUV1H470JCX	S.M.CAP	50V	47pF	
C609	ECUV1H470JCX	S.M.CAP	50V	47pF	
C610	ECA1HM101GB	ELECT	50V	100pF	
C611	ECUV1H104ZFX	S.M.CAP	50V	100nF	
C612	ECUV1H103KBX	S.M.CAP	50V	10nF	
C613	ECUV1H103KBX	S.M.CAP	50V	10nF	
C614	ECUV1H104ZFX	S.M.CAP	50V	100nF	
C623	ECUV1H104ZFW	S.M.CAP	50V	100nF	
C630	ERJ8GEY0R00	S.M.CAR	125W	5%	Ω
C802	ECQU2A823MNB	FILM	200V	82nF	
C803	ECKC2H472J	CERAMIC	500V	4.7nF	△
C804	ECKC2H472J	CERAMIC	500V	4.7nF	△
C805	ECKC2H472J	CERAMIC	500V	4.7nF	△
C806	ECKC2H472J	CERAMIC	500V	4.7nF	△
C807	ECOS2GA101BB	ELECT	400V	100μF	
C808	ECQB1H333J	FILM	50V	33nF	
C809	ECKC3D471JB	CERAMIC	2KV	470pF	△
C810	ECA1VM101GB	ELECT	35V	100pF	
C811	ECA1JM100GB	ELECT	63V	10pF	
C812	ECA2CHG221E	ELECT	160V	220pF	
C817	ECA1VM101GB	ELECT	35V	100pF	
C818	ECKWNA471MBCC	CERAMIC	250V	470pF	
C820	ECKWNA332MECC	CERAMIC	250V	3.3nF	
C821	ECKC3A101J	CERAMIC	1.0KV	100pF	
C853	ECA1EM102GB	ELECT	25V	1nF	
C854	ECA1VM471E	ELECT	35V	470pF	
C855	ECUV1H104ZFX	S.M.CAP	50V	100nF	
C856	ECUV1H104ZFX	S.M.CAP	50V	100nF	
C857	ECA1HM101GB	ELECT	50V	100pF	
C858	ECA1AM222B	ELECT	10V	2.2nF	
C859	ECUV1H104ZFX	S.M.CAP	50V	100nF	
C860	ECA1HM101GB	ELECT	50V	100pF	
C861	ECA1CM102B	ELECT	16V	1nF	
C1201	ECA1EM102GB	ELECT	25V	1nF	
C1202	ECA1EM101GB	ELECT	25V	1μF	
C1203	ECA1EM471GB	ELECT	25V	470pF	
C1204	ECUV1H471KBX	S.M.CAP	50V	470pF	
C1205	ECUV1H471KBX	S.M.CAP	50V	470pF	
C1206	ECUV1H471KBX	S.M.CAP	50V	470pF	
C1207	ECUV1H471KBX	S.M.CAP	50V	470pF	
C1208	ECUV1H471KBX	S.M.CAP	50V	470pF	
C1210	ECUV1H473KBX	S.M.CAP	50V	47nF	
C1218	ECA1HM010GB	ELECT	50V	1pF	

Ref No.	Part No.	Description			
C1219	ECUV1H104ZFX	S.M.CAP	50V	100nF	
C1220	ECA0JM101G	ELECT	6.3V	100pF	
C1221	ECUV1H331JCX	S.M.CAP	50V	330pF	
C1226	ECUV1H104ZFX	S.M.CAP	50V	100nF	
C1227	ECA1HM101GB	ELECT	50V	100pF	
C1228	ECUV1H470GCG	S.M.CAP	50V	47pF	
C1229	ECUV1H470GCG	S.M.CAP	50V	47pF	
C1232	ECUV1H104ZFX	S.M.CAP	50V	100nF	
C1234	ECUV1H104ZFX	S.M.CAP	50V	100nF	
C1241	ECA1HM101GB	ELECT	50V	100pF	
C1244	ECA1CM100GB	ELECT	16V	10pF	
C1249	ECUV1H104ZFX	S.M.CAP	50V	100nF	
C1255	ECA1HM101GB	ELECT	50V	100pF	
C1256	ECUV1H104KBX	S.M.CAP	50V	100nF	
C1257	ECUV1H561JCX	S.M.CAP	50V	560pF	
C1258	ECA1CM100GB	ELECT	16V	10pF	
C1259	ECUV1H150JCX	S.M.CAP	50V	15pF	
C1260	ECUV1H560JCX	S.M.CAP	50V	56pF	
C1261	ECA1HM101GB	ELECT	50V	100pF	
C1262	ECUV1H390JCX	S.M.CAP	50V	39pF	
C1263	ECUV1H390JCX	S.M.CAP	50V	39pF	
C1264	ECUV1H390JCX	S.M.CAP	50V	39pF	
C1265	ECUV1H560JCX	S.M.CAP	50V	56pF	
C3101	ECUV1H101JCX	S.M.CAP	50V	100pF	
C3102	ECUV1H561KBX	S.M.CAP	50V	560pF	
C3104	ECUV1H102KBX	S.M.CAP	50V	1nF	
C3105	ECUV1H101JCX	S.M.CAP	50V	100pF	
C3109	ECUV1H561JCX	S.M.CAP	50V	560pF	
C3110	ECA1HM3R3GB	ELECT	50V	3.3μF	
C3113	ECUV1H103KBX	S.M.CAP	50V	10nF	
C3115	ECEA1CN100	ELECT	16V	10μF	
C3117	ECUV1H104ZFX	S.M.CAP	50V	100nF	
C3118	ECEA1CN100	ELECT	16V	10μF	
C3119	ECEA1CN100	ELECT	16V	10μF	
C3120	ECA1AM471GB	ELECT	10V	470pF	

DIODES

D010	MA4150	DIODE
D011	MA4150	DIODE
D304	1SS355TE-17	DIODE
D306	MTZJT-774.7A	DIODE
D307	MTZJT-774.7A	DIODE
D351	MA165TA5	DIODE
D352	MA165TA5	DIODE
D353	MA165TA5	DIODE
D354	MA165TA5	DIODE
D452	ERA15-02V3	DIODE
D453	MA165TA5	DIODE
D454	MA165TA5	DIODE
D455	MA165TA5	DIODE
D503	MA165TA5	DIODE
D504	MA165TA5	DIODE
D505	1SR124-4AT82	DIODE
D506	MTZJ33B	DIODE
D541	MA165TA5	DIODE
D542	MA165TA5	DIODE
D551	TVSRH2F-LFB3	DIODE
D552	TVSRU2AMLFA5	DIODE
D553	1SR124-4AT82	DIODE
D554	1SR124-4AT82	DIODE
D555	ERA22-02V3	DIODE
D556	MA167TA5	DIODE
D557	1SR124-4AT82	DIODE
D801	EMO2BMV0	DIODE
D802	EMO2BMV0	DIODE
D803	EMO2BMV0	DIODE
D804	EMO2BMV0	DIODE
D805	232266296319	THERMISTOR
D808	1SR124-4AT82	DIODE
D809	1SR124-4AT82	DIODE

Ref No.	Part No.	Description
D810	RU3LFA1	DIODE
D811	1SR124-4AT82	DIODE
D812	R2KNLFA1	DIODE
D814	MA165TA5	DIODE
D815	1SR124-4AT82	DIODE
D816	1SR124-4AT82	DIODE
D851	TVSRU3AMLFA5	DIODE
D852	TVSRU2AMV1	DIODE
D857	MA165TA5	DIODE
D858	MA165TA5	DIODE
D859	MA165TA5	DIODE
D860	MA165TA5	DIODE
D861	MA165TA5	DIODE
D1202	MA170	DIODE
D1203	SLR56UR3FLF	LED
D1205	MA170	DIODE
D1207	MTZJT-778.2A	DIODE
D1208	MA170	DIODE
D1209	MTZJT-775.1C	DIODE
D1211	MA165TA5	DIODE
D1212	MA165TA5	DIODE
D1213	MA165TA5	DIODE
D1214	MA170	DIODE
D1217	MA165TA5	DIODE
D1218	MA165TA5	DIODE
D1219	MA165TA5	DIODE
D1220	MA165TA5	DIODE
D1221	MA165TA5	DIODE
D1222	MA165TA5	DIODE
D1224	MA165TA5	DIODE
D1301	MTZJT-775.1A	DIODE
D1311	MA165TA5	DIODE
D3101	MA165TA5	DIODE

FUSES

F801	2153.15H	FUSE	△
F8011	EYF52BC	FUSE HOLDER	
F8012	EYF52BC	FUSE HOLDER	

TERMINALS AND LINKS

JC1	ERJ6GEY0R00	S.M.CARB	0.1W	5%	0Ω
JC11	ERJ6GEY0R00	S.M.CARB	0.1W	5%	0Ω
JC12	ERJ6GEY0R00	S.M.CARB	0.1W	5%	0Ω
JC14	ERJ8GEY0R00	S.M.CARB	.125W	5%	0Ω
JC2	ERJ6GEY0R00	S.M.CARB	0.1W	5%	0Ω
JC20	ERJ6GEY0R00	S.M.CARB	0.1W	5%	0Ω
JC21	ERJ6GEY0R00	S.M.CARB	0.1W	5%	0Ω
JC22	ERJ6GEY0R00	S.M.CARB	0.1W	5%	0Ω
JC23	ERJ6GEY0R00	S.M.CARB	0.1W	5%	0Ω
JC24	ERJ8GEY0R00	S.M.CARB	.125W	5%	0Ω
JC25	ERJ8GEY0R00	S.M.CARB	.125W	5%	0Ω
JC26	ERJ6GEY0R00	S.M.CARB	0.1W	5%	0Ω
JC27	ERJ8GEY0R00	S.M.CARB	.125W	5%	0Ω
JC28	ERJ8GEY0R00	S.M.CARB	.125W	5%	0Ω
JC3	ERJ6GEY0R00	S.M.CARB	0.1W	5%	0Ω
JC7	ERJ6GEY0R00	S.M.CARB	0.1W	5%	0Ω
JC8	ERJ6GEY0R00	S.M.CARB	0.1W	5%	0Ω
JC9	ERJ6GEY0R00	S.M.CARB	0.1W	5%	0Ω
JEAKK	ERJ6GEY0R00	S.M.CARB	0.1W	5%	0Ω
JEANK	ERJ6GEY0R00	S.M.CARB	0.1W	5%	0Ω
JEJK	ERJ6GEY0R00	S.M.CARB	0.1W	5%	0Ω
JEPK	ERJ6GEY0R00	S.M.CARB	0.1W	5%	0Ω
JEXK	ERJ6GEY0R00	S.M.CARB	0.1W	5%	0Ω
JEZK	ERJ6GEY0R00	S.M.CARB	0.1W	5%	0Ω
JK3102	TJB16663	A.V.TERMINAL			
JYAK	ERJ6GEY0R00	S.M.CARB	0.1W	5%	0Ω
J321	EXCELSA35V	COIL			

Ref No.	Part No.	Description
COILS		
L010	EXCELSA35T	COIL
L012	EXCELSA35T	COIL
L103	EQV7EN211Q	COIL
L105	TLTR22K991R	COIL
L106	TLTACT6R8K	COIL
L107	TLTACT6R8K	COIL
L201	TLTACT150K	COIL
L202	TLTACT4R7K	COIL
L301	TLTACT100K	COIL
L451	EXCELSA35T	COIL
L801	ELF18D281A	COIL
L803	EXCELSA35T	COIL
L804	EXCELDR35V	COIL
L851	EXCELSA35T	COIL
L852	EXCELSA35T	COIL
L1201	EXCELSA35T	COIL
L1202	TLTACT331K	COIL
L1203	TLTACT100K	COIL
L1204	ELJNA6R8GF	SM.CARB0.125W 5% 6R8Ω
L1207	TLTACT100K	COIL
L1208	TLTACT100K	COIL
L1209	EXCELSA35T	COIL

TRANSISTORS

Q101	BF370-126	TRANSISTOR
Q102	BC847B	TRANSISTOR
Q201	BC847B	TRANSISTOR
Q202	BC847B	TRANSISTOR
Q251	BC847B	TRANSISTOR
Q252	BC857B	TRANSISTOR
Q253	BC847B	TRANSISTOR
Q301	BC847B	TRANSISTOR
Q302	BC847B	TRANSISTOR
Q303	BC847B	TRANSISTOR
Q351	2SC1473-RN	TRANSISTOR
Q352	2SC1473-RN	TRANSISTOR
Q353	2SC1473-RN	TRANSISTOR
Q354	BC857B	TRANSISTOR
Q453	BC847B	TRANSISTOR
Q454	BC847B	TRANSISTOR
Q501	2SD2398-M2	TRANSISTOR
Q502	BC857B	TRANSISTOR
Q503	BC847B	TRANSISTOR
Q504	BC847B	TRANSISTOR
Q551	BU2506DFRB	TRANSISTOR
Q801	BC847B	TRANSISTOR
Q802	2SD965-R	TRANSISTOR
Q1201	BC847B	TRANSISTOR
Q1202	BC847B	TRANSISTOR
Q1203	BC847B	TRANSISTOR
Q1204	2SC1317-TA	TRANSISTOR
Q1205	BC847B	TRANSISTOR
Q1207	BC847B	TRANSISTOR
Q1208	BC847B	TRANSISTOR
Q1209	BC847B	TRANSISTOR
Q1210	BC857B	TRANSISTOR
Q1211	BC857B	TRANSISTOR
Q1212	BC847B	TRANSISTOR
Q1213	BC847B	TRANSISTOR
Q1240	BC847B	TRANSISTOR
Q1295	BC857B	TRANSISTOR
Q1296	BC847B	TRANSISTOR
Q3101	2SC1318-S	TRANSISTOR
Q3103	2SD1328STX	TRANSISTOR
Q3104	BC857B	TRANSISTOR
Q3105	BC857B	TRANSISTOR
Q3106	BC857B	TRANSISTOR
Q3107	BC857B	TRANSISTOR

Ref No.	Part No.	Description			
Q3108	BC857B	TRANSISTOR			
RESISTOR					
RL1201	TSE1885-1	RELAY			
R010	ERJ6GEYJ153	S.M.CARB	0.1W	5%	15KΩ
R011	ERJ6GEYJ271	S.M.CARB	0.1W	5%	270Ω
R013	ERJ6GEYJ223	S.M.CARB	0.1W	5%	22KΩ
R014	ERG2SJS273	METAL	2W	5%	27KΩ
R016	ELJFC6R8KF	COIL			
R017	ELJFC6R8KF	COIL			
R101	ERJ6GEYJ101	S.M.CARB	0.1W	5%	100Ω
R103	ERJ6GEYJ272	S.M.CARB	0.1W	5%	2K7Ω
R104	ERJ6GEYJ822	S.M.CARB	0.1W	5%	8K2Ω
R105	ERJ6GEYJ220	S.M.CARB	0.1W	5%	22Ω
R106	ERJ6GEYJ821	S.M.CARB	0.1W	5%	820Ω
R107	ERJ6GEYJ102	S.M.CARB	0.1W	5%	1KΩ
R108	ERJ6GEYJ124	S.M.CARB	0.1W	5%	120KΩ
R109	ERJ6GEY0R00	S.M.CARB	0.1W	5%	0Ω
R110	ERJ6GEYJ392	S.M.CARB	0.1W	5%	3K9Ω
R112	ERJ8GEY0R00	S.M.CARB	.125W	5%	0Ω
R113	ERJ6GEYJ124	S.M.CARB	0.1W	5%	120KΩ
R114	ERJ6GEYJ123	S.M.CARB	0.1W	5%	12KΩ
R115	ERJ6GEYJ102	S.M.CARB	0.1W	5%	1KΩ
R116	ERJ6GEYJ152	S.M.CARB	0.1W	5%	1K5Ω
R117	ERJ6GEYJ562	S.M.CARB	0.1W	5%	5K6Ω
R202	ERJ6GEY0R00	S.M.CARB	0.1W	5%	0Ω
R203	ERJ6GEYJ122	S.M.CARB	0.1W	5%	1K2Ω
R205	ERJ6GEYJ222	S.M.CARB	0.1W	5%	2K2Ω
R206	ERJ6GEYJ182	S.M.CARB	0.1W	5%	1K8Ω
R221	ERJ6GEYJ221	S.M.CARB	0.1W	5%	220Ω
R226	ERJ6GEY0R00	S.M.CARB	0.1W	5%	0Ω
R227	ERJ6GEYJ562	S.M.CARB	0.1W	5%	5K6Ω
R229	ERJ6GEYJ470	S.M.CARB	0.1W	5%	47Ω
R251	ERJ6GEYJ3R3	S.M.CARB	0.1W	5%	3R3Ω
R252	ERJ6GEYJ562	S.M.CARB	0.1W	5%	5K6Ω
R254	ERJ6GEYJ121	S.M.CARB	0.1W	5%	120Ω
R255	ERJ6GEYJ181	S.M.CARB	0.1W	5%	180Ω
R256	ERJ6GEYJ104	S.M.CARB	0.1W	5%	100KΩ
R257	ERQ1CJP120	METAL	1W	5%	12Ω
R259	ERJ6GEYJ331	S.M.CARB	0.1W	5%	330Ω
R260	ERJ6GEYJ332	S.M.CARB	0.1W	5%	3K3Ω
R261	ERJ6GEYJ682	S.M.CARB	0.1W	5%	6K8Ω
R262	ERJ6GEYF104V	SM.CARB0.125W		1%	100KΩ
R263	ERJ6GEYF622V	SM.CARB0.125W		1%	6K2Ω
R264	ERJ6GEYJ103	S.M.CARB	0.1W	5%	10KΩ
R301	ERJ6GEYJ102	S.M.CARB	0.1W	5%	1KΩ
R302	ERJ6GEYJ102	S.M.CARB	0.1W	5%	1KΩ
R303	ERJ6GEYJ472	S.M.CARB	0.1W	5%	4K7Ω
R304	ERJ6ENF2201	SM.CARB0.125W		5%	200Ω
R305	ERJ6GEYJ471	S.M.CARB	0.1W	5%	470Ω
R306	ERJ6GEYJ471	S.M.CARB	0.1W	5%	470Ω
R307	ERJ6GEYJ471	S.M.CARB	0.1W	5%	470Ω
R309	ERJ6GEYJ102	S.M.CARB	0.1W	5%	1KΩ
R310	ERJ6GEY0R00	S.M.CARB	0.1W	5%	0Ω
R311	ERJ6GEYJ181	S.M.CARB	0.1W	5%	180Ω
R312	ERJ6GEYJ181	S.M.CARB	0.1W	5%	180Ω
R313	ERQ14AJ470	METAL	0.25W	5%	47Ω
R314	ERJ6GEYJ561	S.M.CARB	0.1W	5%	560Ω
R315	ERJ6GEYJ471	S.M.CARB	0.1W	5%	470Ω
R316	ERQ14AJ470	METAL	0.25W	5%	47Ω
R317	ERJ6GEYJ102	S.M.CARB	0.1W	5%	1KΩ
R318	ERJ6GEYJ102	S.M.CARB	0.1W	5%	1KΩ
R319	ERJ6GEYJ102	S.M.CARB	0.1W	5%	1KΩ
R320	ERJ6GEYJ101	S.M.CARB	0.1W	5%	100Ω
R351	ERG1SJ123	METAL	1W	5%	12KΩ
R352	ERG1SJ123	METAL	1W	5%	12KΩ
R353	ERG1SJ123	METAL	1W	5%	12KΩ
R366	ERJ6GEYJ681	S.M.CARB	0.1W	5%	680Ω
R367	ERJ6GEYJ681	S.M.CARB	0.1W	5%	680Ω
R368	ERJ6GEYJ681	S.M.CARB	0.1W	5%	680Ω

Ref No.	Part No.	Description			
R369	ERJ6GEYJ682	S.M.CARB	0.1W	5%	6K8Ω
R370	ERJ6GEYJ682	S.M.CARB	0.1W	5%	6K8Ω
R371	ERJ6GEYJ682	S.M.CARB	0.1W	5%	6K8Ω
R372	ERJ6GEYJ103	S.M.CARB	0.1W	5%	10KΩ
R373	ERJ6GEYJ391	S.M.CARB	0.1W	5%	390Ω
R374	ERJ6GEYJ103	S.M.CARB	0.1W	5%	10KΩ
R375	ERDS1TJ182	CARBON	0.5W	5%	1K8Ω
R386	ERDS1TJ182	CARBON	0.5W	5%	1K8Ω
R387	ERDS1TJ182	CARBON	0.5W	5%	1K8Ω
R401	ERJ6ENF9100	SM.CARB0.125W		5%	10Ω
R402	ERJ6ENF8201	SM.CARB0.125W		5%	200Ω
R403	ERJ6ENF6801	SM.CARB0.125W		5%	800Ω
R451	ERDS1TJ331	CARBON	0.5W	5%	330Ω
R452	ERJ6GEYJ1R0	SM.CARB0.125W		5%	1RΩ
R453	ERDS1TJ1R5	CARBON	0.5W	5%	1R5Ω
R454	ERJ6GEYF153V	SM.CARB0.125W		1%	15KΩ
R456	ERQ25CKF5601	METAL	0.25W	1%	5K6Ω
R457	ERJ6GEYJ103	S.M.CARB	0.1W	5%	10KΩ
R458	ERD25TJ683	CARBON	0.25W	5%	68KΩ
R459	ERJ6GEYJ332	S.M.CARB	0.1W	5%	3K3Ω
R460	ERJ6GEYJ473	S.M.CARB	0.1W	5%	47KΩ
R461	ERJ6GEYJ473	S.M.CARB	0.1W	5%	47KΩ
R462	ERJ6GEYJ473	S.M.CARB	0.1W	5%	47KΩ
R501	ERJ6GEYJ391	S.M.CARB	0.1W	5%	390Ω
R502	ERJ6GEYJ681	S.M.CARB	0.1W	5%	680Ω
R503	ERG3SJS101	METAL	3W	5%	10Ω
R504	ERG2ANJ471	METAL	2W	5%	470Ω
R505	ERJ6GEYJ433	SM.CARB0.125W		5%	43KΩ
R506	ERJ6GEYJ753	S.M.CARB	0.1W	5%	75KΩ
R508	ERJ6GEYJ753	S.M.CARB	0.1W	5%	75KΩ
R510	ERJ6GEYJ561	S.M.CARB	0.1W	5%	560Ω
R511	ERJ6GEYJ334	S.M.CARB	0.1W	5%	330KΩ
R513	ERJ6GEYJ471	S.M.CARB	0.1W	5%	470Ω
R515	ERJ6GEYJ102	S.M.CARB	0.1W	5%	1KΩ
R516	ERJ6GEYJ103	S.M.CARB	0.1W	5%	10KΩ
R518	ERJ6ENF1302	SM.CARB0.125W		5%	3KΩ
R519	ERJ6GEYJ754	S.M.CARB	0.1W	5%	750KΩ
R520	ERJ6GEYJ334	S.M.CARB	0.1W	5%	330KΩ
R521	ERJ6GEYJ103	S.M.CARB	0.1W	5%	10KΩ
R522	ERJ6GEYJ394	S.M.CARB	0.1W	5%	390KΩ
R541	ERJ6GEYJ332	S.M.CARB	0.1W	5%	3K3Ω
R542	ERJ6GEYJ242	S.M.CARB	0.1W	5%	2K4Ω
R543	ERJ6GEYJ682	S.M.CARB	0.1W	5%	6K8Ω
R551	ERDS1TJ1R5	CARBON	0.5W	5%	1R5Ω
R552	ERDS1TJ1R5	CARBON	0.5W	5%	1R5Ω
R555	ERQ12HKR22	FUSIBLE	0.5W	5%	R22Ω
R557	ERJ6GEYJ562	S.M.CARB	0.1W	5%	5K6Ω
R560	ERDS1TJ304	CARBON	0.5W	5%	300KΩ
R601	ERJ6GEYJ332	S.M.CARB	0.1W	5%	3K3Ω
R602	ERJ6GEYJ222	S.M.CARB	0.1W	5%	2K2Ω
R603	ERJ6GEYJ103	S.M.CARB	0.1W	5%	10KΩ
R604	ERJ6GEYJ472	S.M.CARB	0.1W	5%	4K7Ω
R605	ERJ6GEYJ103	S.M.CARB	0.1W	5%	10KΩ
R606	ERJ6GEYJ103	S.M.CARB	0.1W	5%	10KΩ
R611	ERJ6GEY0R00	S.M.CARB	0.1W	5%	0Ω
R612	ERJ6GEY0R00	S.M.CARB	0.1W	5%	0Ω
R613	ERJ6GEYJ395	SM.CARB0.125W		5%	3M9Ω
R801	ERF5ZK2R7	WOUND	5W	20%	2R7Ω
R804	ERDS1TJ224	CARBON	0.5W	5%	220KΩ
R805	ERW2PKR33	WIRE	2W	10%	R33Ω
R806	ERJ6GEYJ102	S.M.CARB	0.1W	5%	1KΩ
R807	ERG2ANJ101	METAL	2W	5%	100Ω
R808	ERG12SJ561P	METAL	12W	5%	560Ω
R809	ERG2SJ560P	METAL	2W	5%	56Ω
R810	ERQ12HJ100	METAL	0.5W	5%	10Ω
R811	ERDS1TJ224	CARBON	0.5W	5%	220KΩ
R813	ERJ6GEYJ202	SM.CARB0.125W		5%	2KΩ
R814	ERD75TAJ825	CARBON	0.75W	5%	8M2Ω
R819	ERDS1TJ104	CARBON	0.5W	5%	100KΩ
R853	ERG2ANJ270	METAL	2W	5%	27Ω
R857	ERJ6GEYJ102	S.M.CARB	0.1W	5%	1KΩ
R858	ERJ6GEYJ102	S.M.CARB	0.1W	5%	1KΩ

Ref No.	Part No.	Description				
R859	ERJ6GEYJ102	S.M.CARB	0.1W	5%	1KΩ	
R860	ERJ6GEYJ102	S.M.CARB	0.1W	5%	1KΩ	
R861	ERJ6GEY0R00	S.M.CARB	0.1W	5%	0Ω	
R1201	ERQ1CJP2R2	FUSABLE	1W	5%	2R2Ω	△
R1202	ERJ6GEYJ562	S.M.CARB	0.1W	5%	5K6Ω	
R1203	ERJ6GEYJ562	S.M.CARB	0.1W	5%	5K6Ω	
R1204	ERJ6GEYJ562	S.M.CARB	0.1W	5%	5K6Ω	
R1205	ERJ6GEYJ562	S.M.CARB	0.1W	5%	5K6Ω	
R1206	ERJ6GEYJ562	S.M.CARB	0.1W	5%	5K6Ω	
R1208	ERJ6GEYJ101	S.M.CARB	0.1W	5%	100Ω	
R1211	ERJ6GEYJ101	S.M.CARB	0.1W	5%	100Ω	
R1212	ERJ6GEYJ101	S.M.CARB	0.1W	5%	100Ω	
R1214	ERJ6GEYJ103	S.M.CARB	0.1W	5%	10KΩ	
R1217	ERJ6ENF1202	S.M.CARB	0.1W	1%	1K2Ω	
R1218	ERO50PKF6203	METAL	50W	1%	620KΩ	△
R1219	ERJ6GEYJ562	S.M.CARB	0.1W	5%	5K6Ω	
R1220	ERJ6GEYJ472	S.M.CARB	0.1W	5%	4K7Ω	
R1221	ERJ6GEYJ271	S.M.CARB	0.1W	5%	270Ω	
R1222	ERJ6GEYJ330	S.M.CARB	0.1W	5%	33Ω	
R1226	ERJ6GEYJ102	S.M.CARB	0.1W	5%	1KΩ	
R1227	ERJ6GEYJ101	S.M.CARB	0.1W	5%	100Ω	
R1228	ERJ6GEYJ101	S.M.CARB	0.1W	5%	100Ω	
R1229	ERJ6GEYJ101	S.M.CARB	0.1W	5%	100Ω	
R1231	ERJ6GEYJ101	S.M.CARB	0.1W	5%	100Ω	
R1232	ERJ6GEYJ562	S.M.CARB	0.1W	5%	5K6Ω	
R1233	ERJ6GEYJ562	S.M.CARB	0.1W	5%	5K6Ω	
R1235	ERJ6GEYJ152	S.M.CARB	0.1W	5%	1K5Ω	
R1236	ERJ6GEYJ223	S.M.CARB	0.1W	5%	22KΩ	
R1237	ERJ6GEYJ222	S.M.CARB	0.1W	5%	2K2Ω	
R1238	ERJ6GEYJ101	S.M.CARB	0.1W	5%	100Ω	
R1239	ERJ6GEYJ101	S.M.CARB	0.1W	5%	100Ω	
R1240	ERJ6GEYJ101	S.M.CARB	0.1W	5%	100Ω	
R1243	ERJ6GEYJ101	S.M.CARB	0.1W	5%	100Ω	
R1244	ERJ6GEYJ101	S.M.CARB	0.1W	5%	100Ω	
R1246	ERD25TJ272	CARBON	0.25W	5%	2K7Ω	
R1247	ERD25TJ221	CARBON	0.25W	5%	220Ω	
R1248	ERJ6GEYJ223	S.M.CARB	0.1W	5%	22KΩ	
R1249	ERDS1TJ121	CARBON	0.5W	5%	120Ω	
R1250	ERDS1TJ560	CARBON	0.5W	5%	56Ω	
R1252	ERJ6GEYJ101	S.M.CARB	0.1W	5%	100Ω	
R1255	ERJ6GEYJ102	S.M.CARB	0.1W	5%	1KΩ	
R1257	ERJ6GEYJ562	S.M.CARB	0.1W	5%	5K6Ω	
R1258	ERJ6GEY0R00	S.M.CARB	0.1W	5%	0Ω	
R1259	ERJ6GEYJ102	S.M.CARB	0.1W	5%	1KΩ	
R1261	ERJ6GEYJ122	S.M.CARB	0.1W	5%	1K2Ω	
R1263	ERJ6GEYJ122	S.M.CARB	0.1W	5%	1K2Ω	
R1265	ERJ6GEYJ122	S.M.CARB	0.1W	5%	1K2Ω	
R1266	ERJ6GEYJ102	S.M.CARB	0.1W	5%	1KΩ	
R1267	ERJ6GEYJ101	S.M.CARB	0.1W	5%	100Ω	
R1268	ERJ6GEYJ101	S.M.CARB	0.1W	5%	100Ω	
R1269	ERJ6GEYJ101	S.M.CARB	0.1W	5%	100Ω	
R1270	ERJ6GEYJ101	S.M.CARB	0.1W	5%	100Ω	
R1271	ERJ6GEYJ101	S.M.CARB	0.1W	5%	100Ω	
R1272	ERJ6GEYJ101	S.M.CARB	0.1W	5%	100Ω	
R1273	ERJ6GEYJ333	S.M.CARB	0.1W	5%	33KΩ	
R1274	ERJ6GEYJ104	S.M.CARB	0.1W	5%	100KΩ	
R1276	ERJ6GEYJ102	S.M.CARB	0.1W	5%	1KΩ	
R1282	ERJ6GEYJ102	S.M.CARB	0.1W	5%	1KΩ	
R1283	ERJ6GEYJ102	S.M.CARB	0.1W	5%	1KΩ	
R1284	ERJ6GEYJ102	S.M.CARB	0.1W	5%	1KΩ	
R1285	ERJ6GEYJ222	S.M.CARB	0.1W	5%	2K2Ω	
R1286	ERJ6GEYJ222	S.M.CARB	0.1W	5%	2K2Ω	
R1287	ERJ6GEYJ222	S.M.CARB	0.1W	5%	2K2Ω	
R1288	ERJ6GEYJ222	S.M.CARB	0.1W	5%	2K2Ω	
R1289	ERJ6GEYJ562	S.M.CARB	0.1W	5%	5K6Ω	
R1293	ERJ6GEYJ103	S.M.CARB	0.1W	5%	10KΩ	
R1294	ERJ6GEYJ103	S.M.CARB	0.1W	5%	10KΩ	
R1295	ERJ6GEYJ103	S.M.CARB	0.1W	5%	10KΩ	
R1296	ERJ6GEYJ103	S.M.CARB	0.1W	5%	10KΩ	
R1298	ERJ6GEYJ103	S.M.CARB	0.1W	5%	10KΩ	
R1303	ERJ6GEYJ102	S.M.CARB	0.1W	5%	1KΩ	
R1309	ERJ6GEYJ562	S.M.CARB	0.1W	5%	5K6Ω	

Ref No.	Part No.	Description				
R1311	ERJ6GEYJ103	S.M.CARB	0.1W	5%	10KΩ	
R3101	ERJ6GEYJ562	S.M.CARB	0.1W	5%	5K6Ω	
R3102	ERJ6GEYJ562	S.M.CARB	0.1W	5%	5K6Ω	
R3103	ERJ6GEYJ564	S.M.CARB	0.1W	5%	560KΩ	
R3104	ERJ6GEYJ104	S.M.CARB	0.1W	5%	100KΩ	
R3105	ERJ6GEYJ750	S.M.CARB	0.1W	5%	75Ω	
R3106	ERJ6GEYJ750	S.M.CARB	0.1W	5%	75Ω	
R3107	ERJ6GEYJ750	S.M.CARB	0.1W	5%	75Ω	
R3108	ERJ6GEYJ750	S.M.CARB	0.1W	5%	75Ω	
R3109	ERJ6GEYJ221	S.M.CARB	0.1W	5%	220Ω	
R3110	ERJ6GEYJ222	S.M.CARB	0.1W	5%	2K2Ω	
R3111	ERJ6GEYJ101	S.M.CARB	0.1W	5%	100Ω	
R3114	ERJ6GEYJ101	S.M.CARB	0.1W	5%	100Ω	
R3115	ERDS1TJ750	CARBON	0.5W	5%	75Ω	
R3120	ERJ6GEYJ750	S.M.CARB	0.1W	5%	75Ω	
R3121	ERJ6GEYJ562	S.M.CARB	0.1W	5%	5K6Ω	
R3122	ERJ6GEYJ221	S.M.CARB	0.1W	5%	220Ω	
R3123	ERJ6GEYJ221	S.M.CARB	0.1W	5%	220Ω	
R3124	ERJ6GEYJ221	S.M.CARB	0.1W	5%	220Ω	
R3125	ERJ6GEY0R00	S.M.CARB	0.1W	5%	0Ω	
R3126	ERJ6GEYJ153	S.M.CARB	0.1W	5%	15KΩ	
R3127	ERJ6GEYJ101	S.M.CARB	0.1W	5%	100Ω	
R3128	ERJ6GEYJ273	S.M.CARB	0.1W	5%	27KΩ	
R3130	ERJ6GEYJ102	S.M.CARB	0.1W	5%	1KΩ	
R3132	ERJ6GEYJ103	S.M.CARB	0.1W	5%	10KΩ	
R3133	ERJ6GEYJ223	S.M.CARB	0.1W	5%	22KΩ	
R3134	ERJ6GEYJ102	S.M.CARB	0.1W	5%	1KΩ	
R3136	ERJ6GEYJ103	S.M.CARB	0.1W	5%	10KΩ	
R3137	ERJ6GEYJ223	S.M.CARB	0.1W	5%	22KΩ	
R3138	ERJ6GEYJ102	S.M.CARB	0.1W	5%	1KΩ	
R3140	ERJ6GEYJ103	S.M.CARB	0.1W	5%	10KΩ	
R3141	ERJ6GEYJ223	S.M.CARB	0.1W	5%	22KΩ	
R3142	ERJ6GEYJ102	S.M.CARB	0.1W	5%	1KΩ	
R3143	ERJ6GEYJ181	S.M.CARB	0.1W	5%	180Ω	

SWITCHES

S351	0330660069	CRT SOCKET	
S801	ESB91232A	SWITCH	△
S1201	EVQ23405R	SWITCH	
S1202	EVQ23405R	SWITCH	
S1203	EVQ23405R	SWITCH	
S1204	EVQ23405R	SWITCH	
S1205	EVQ23405R	SWITCH	

TRANSFORMERS

T551	ETH19Z169AZ	TRANSFORMER	
T552	ZTFK33004A	F.B.T.	△
T801	ETS29AK237AC	TRANSFORMER	△
T1201	ETP35KAN617U	TRANSFORMER	

FILTERS

X101	G1963—M100	SAW FILTER	
X201	EFC5R5MS5	FILTER	
X301	EFCWS5504T	FILTER	
X303	TAFCSB503F6	FILTER	
X601	TSS116M6	CRYSTAL	
X1201	CSA18.00MXZ	CRYSTAL	

DIFFERENCES FOR MODEL TX-14S3TC

Ref No.	Part No.	Description
MISCELLANEOUS COMPONENTS		
3)	UR51EC769	BATTERY COVER (REMOTE)
4)	TNQ8E0461-2	REMOTE CONTROL
12)	TBM8E1678	MODEL LABEL
17)	TNP8EE007AB	E P.C.B. ▲
CAPACITORS		
C1230	ECUV1H333KBX	S.M.CAP 50V 33nF
C1231	222236516154	FILM 160V 150nF
C1242	ECUV1H120JCX	S.M.CAP 50V 12pF
C1245	ECUV1H333KBX	S.M.CAP 50V 33nF
C1250	ECUV1H151JCX	S.M.CAP 50V 150pF
C1251	ECQM1H104J	FILM 50V 100nF
C1268	ECA1CM220GB	ELECT 16V 22µF
C1269	ECUV1H181JCX	S.M.CAP 50V 180pF
DIODES		
D1225	MA165TA5	DIODE
INTEGRATED CIRCUITS		
IC1201	SDA5254V11	MICRO
IC1205	XL24C02P-BAF	EAROM
COILS		
L1206	EXCELSA35T	COIL
TRANSISTORS		
Q1214	BC857B	TRANSISTOR
Q1215	BC857B	TRANSISTOR
Q1216	BC847B	TRANSISTOR
RESISTOR		
R1213	ERJ6GEYJ392	S.M.CARB 0.1W 5% 3K9Ω
R1215	ERJ6GEYJ682	S.M.CARB 0.1W 5% 6K8Ω
R1216	ERJ6GEYJ682	S.M.CARB 0.1W 5% 6K8Ω
R1230	ERJ6GEYJ823	S.M.CARB 0.1W 5% 82KΩ
R1241	ERJ6GEYJ822	S.M.CARB 0.1W 5% 8K2Ω
R1242	ERJ6GEYJ434	SM.CARB0.125W 5%430KΩ
R1253	ERJ6GEYJ472	S.M.CARB 0.1W 5% 4K7Ω
R1256	ERJ6GEYJ122	S.M.CARB 0.1W 5% 1K2Ω
R1275	ERJ6GEYJ225	SM.CARB0.125W 5% 2M2Ω
R1277	ERJ6GEYJ103	S.M.CARB 0.1W 5% 10KΩ
R1278	ERJ6GEYJ182	S.M.CARB 0.1W 5% 1K8Ω
R1290	ERJ6GEYJ822	S.M.CARB 0.1W 5% 8K2Ω
R1291	ERJ6GEYJ822	S.M.CARB 0.1W 5% 8K2Ω
R1292	ERJ6GEYJ103	S.M.CARB 0.1W 5% 10KΩ
R1306	ERJ6GEY0R00	S.M.CARB 0.1W 5% 0Ω
R1307	ERJ6GEYJ182	S.M.CARB 0.1W 5% 1K8Ω

DIFFERENCES FOR MODEL TC-14S3RC

Ref No.	Part No.	Description
MISCELLANEOUS COMPONENTS		
1)	UR50RC1112	BATTERY COVER (REMOTE)
2)	TNQ8E0460	REMOTE CONTROL
12)	TBM8E1677	MODEL LABEL
17)	TNP8EE007AK	E P.C.B. ▲
CAPACITORS		
C1230	ERJ6GEY0R00	S.M.CARB 0.1W 5% 0Ω
C1245	ERJ6GEY0R00	S.M.CARB 0.1W 5% 0Ω
C1268	ECA1HM101GB	ELECT 50V 100pF
INTEGRATED CIRCUITS		
IC1201	SDA5222V21	MICRO
IC1205	XL24C02P-BAD	EAROM
TERMINALS AND LINKS		
J145	MA165TA5	DIODE
RESISTOR		
R1215	ERJ6GEY0R00	S.M.CARB 0.1W 5% 0Ω
R1216	ERJ6GEY0R00	S.M.CARB 0.1W 5% 0Ω
R1230	ERJ6GEYJ103	S.M.CARB 0.1W 5% 10KΩ
R1242	ERJ6GEY0R00	S.M.CARB 0.1W 5% 0Ω
R1253	ERJ6GEY0R00	S.M.CARB 0.1W 5% 0Ω
R1275	ERJ6GEY0R00	S.M.CARB 0.1W 5% 0Ω
R1291	ERJ6GEYJ432	S.M.CARB 0.1W 5% 4K3Ω
R1313	ERD25TJ393	CARBON 0.25W 5% 39KΩ

SCHEMATIC DIAGRAM FOR MODELS

**TX-14S3TC/TC-14S3RC
(Z-7 Chassis)**







IMPORTANT SAFETY NOTICE

Components identified by  mark have special characteristics important for safety. When replacing any of these components, use only manufacturer's specified parts.

Notes









1. RESISTOR

All resistors are carbon 1/4W resistor, unless marked as follows:
Unit of resistance is OHM (Ω) (K=1,000, M=1,000,000).

-  : Nonflammable  : Metal Oxide
 : Solid  : Metal Film
 : Wire Wound  : Fuse

2. CAPACITORS

All capacitors are ceramic 50V, unless marked as follows:
Unit of capacitance is μ F, unless otherwise stated.

-  : Temperature Compensation  : Electrolytic
 : Polyester  : Bipolar
 : Metallised Polyester  : Dipped Tantalum
 : Polypropylene  : Z-Type

3. COIL



Unit of inductance is μ H, unless otherwise stated.

4. Components marked 'L' on the schematic diagram shows leadless parts.

5. TEST POINT

-  : Test Point position

6. EARTH SYMBOL



-  : Chassis Earth (Cold)  : Line Earth (Hot)

7. VOLTAGE MEASUREMENT

Voltage is measured by a DC voltmeter.

Measurement conditions are as follows:

- | | |
|-----------------------|------------------------|
| Power source | AC 220V-240V, 50Hz |
| Receiving Signal | Colour Bar signal (RF) |
| All customer controls | Maximum position |

8.  : Indicates the Video signal path
 : Indicates the Audio signal path
 : Indicates the Vertical/Horizontal signal path

9. This schematic diagram is the latest at the time of printing and is subject to change without notice.

Remarks

1. The Power Circuit contains a circuit area which uses a separate power supply to isolate the earth connection. The circuit is defined by HOT and COLD indications in the schematic diagram. All circuits, except the Power Circuit, are COLD. Take the following precautions:

Precautions

- Do not touch the hot part, or the hot and cold parts at the same time, as you are liable to a shock hazard.
- Do not short-circuit the hot and cold circuits as electrical components may be damaged.
- Do not connect an instrument, such as an oscilloscope, to the hot and cold circuits simultaneously, as this may cause fuse failure. Connect the earth of the instruments to the earth connection of the circuit being measured.
- Make sure to disconnect the power plug before removing the chassis.

ZEICHENERKLÄRUNG FÜR MODELL

**TX-14S3TC/TC-14S3RC
(Z-7 Chassis)**

WICHTIGER SICHERHEITSHINWEIS







Teile, die mit einem Hinweis  gekennzeichnet sind, sind wichtig für die Sicherheit. Sollte ein Auswechseln erforderlich sein, sind unbedingt Originalteile einzusetzen.

Anmerkung

1. WIDERSTÄNDE

Alle 1/4Watt Widerstände sind Kohlewiderstände, Abweichungen sind folgt gekennzeichnet.

Die Maßeinheit ist OHM (Ω) (K=1,000 M=1,000,000)









-  : nicht brennbar  : Metal Oxyd
 : Lastwiderstand  : Metal Film
 : Draht  : Sicherung

2. KONDENSATOREN

Alle Kondensatoren sind Keramikausführungen

Spannungsfestigkeit 50V. Abweichungen sind wie folgt gekennzeichnet.

Die Maßeinheit ist μ F, wenn keine anderen Bezeichnungen genannt sind

-  : Temperatur Kompensation  : Electrolyt
 : Polyester  : Bipolar
 : Metallisches Polyester  : Tantal
 : Polypropylen  : Z-Typ

3. SPULEN

Die Maßeinheit ist μ H, Abweichungen sind gekennzeichnet.

4. Mit 'L' gekennzeichnete Teile sind ohne Anschlußdrähte.

5. TESTPUNKTE

-  : Kennzeichnung der Testpunktposition

6. MASSE SYMBOL



-  : Erdung am Chassis  : Erdung an Masse-Leitung

7. SPANNUNGSMESSUNG

Spannungsmessungen sind mit einem DC-Voltmeter durchzuführen. Die Meßbedingungen sind folgende:

Netzspannung AC 220V-240V 50Hz
Wiedergabe Signal Farbbalken-Testbild

Alle übrigen Einstellungen für Benutzer Sollangaben

8.  : Videosignalweg
 : Audiosignalweg
 : Signalweg für Hor/Vert. Synchronsignale

9. Änderungen im Laufe der Fertigung sind möglich.

Bemerkungen

1. Das Schaltnetzteil enthält Bereiche, die direkt mit dem Netz verbunden sind. Diese Bereiche sind im Schalplan mit HOT gekennzeichnet. Alle anderen Schaltungen sind mit COLD gekennzeichnet und haben keine direkte Verbindung mit dem Netz.

Für den netzverbundenen Bereich (HOT) sind folgende Vorsichtsmaßnahmen zu beachten:

- Weder die Leitungen im heißen noch Leitungen im heißen und im kalten Bereich gleichzeitig berühren. Es besteht die Gefahr eines elektrischen Schlags.
- Keinesfalls die Leitungen im heißen Bereich mit denen im kalten Bereich verbinden oder kurzschließen. Dies kann zur Zerstörung von Bauteilen oder Sicherungen führen. Außerdem ist die elektrische Betriebssicherheit des Gerätes nicht mehr gegeben.
- Keine Messinstrumente gleichzeitig an Leitungen im heißen und kalten Bereich anschließen. Sicherungen könnten zerstört werden. Die Erde des Messinstrumentes immer mit der des zu prüfenden Schaltkreises verbinden.
- Vor Ausbau des Chassis, Stecker aus der Netzsteckdose ziehen.

E - BOARD TX - 14S3TC

E BOARD
TNP8EE007

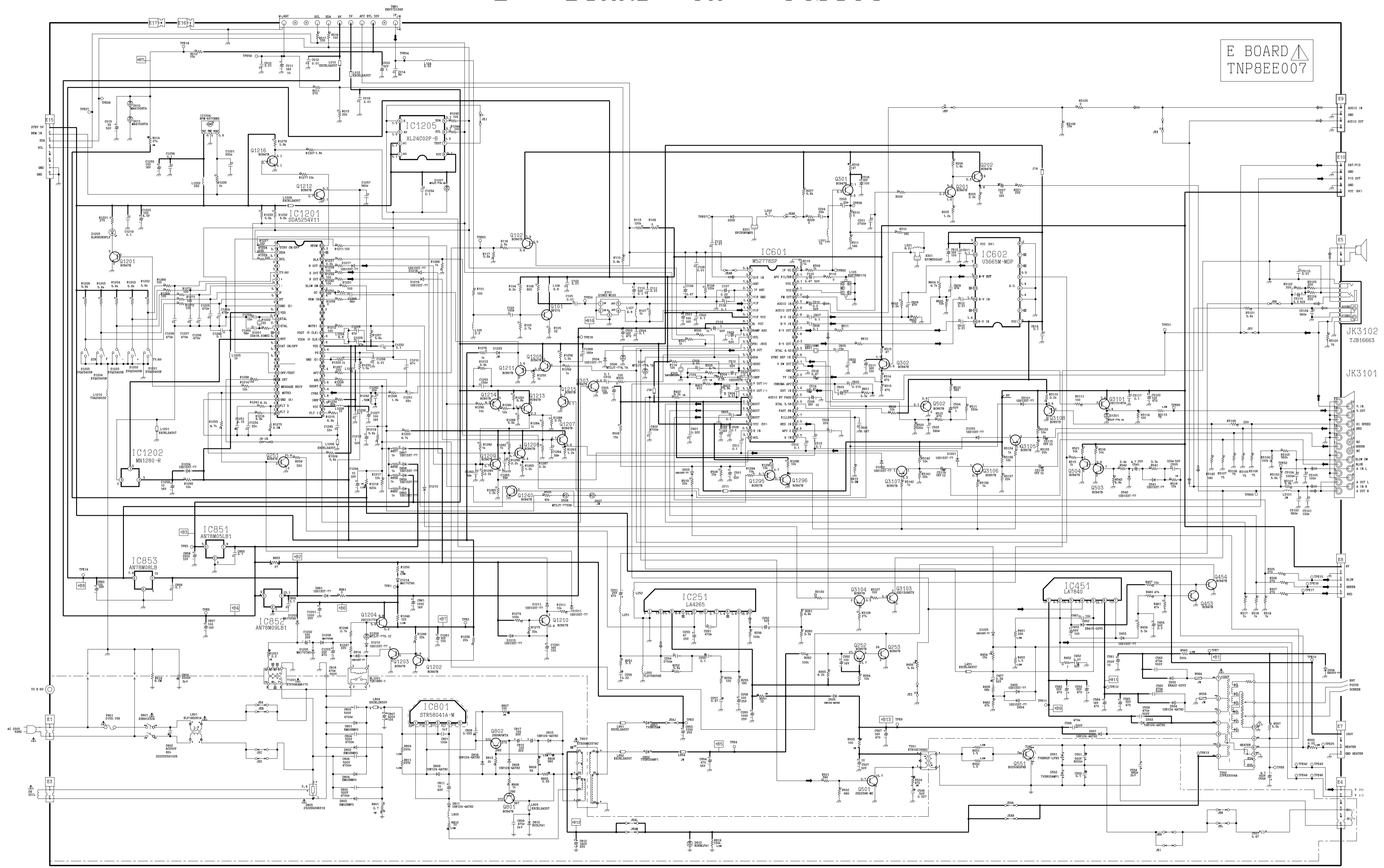

JK3102
TJB16663

JK3101

V. IN
V. OUT
R. IN
R. OUT
A. IN
A. OUT
S. IN
S. OUT

RED
GREEN
BLUE
WHITE

100V
HEATER
DOOR HEATER

E - BOARD TC - 14S3RC

E BOARD
TNP8EE007

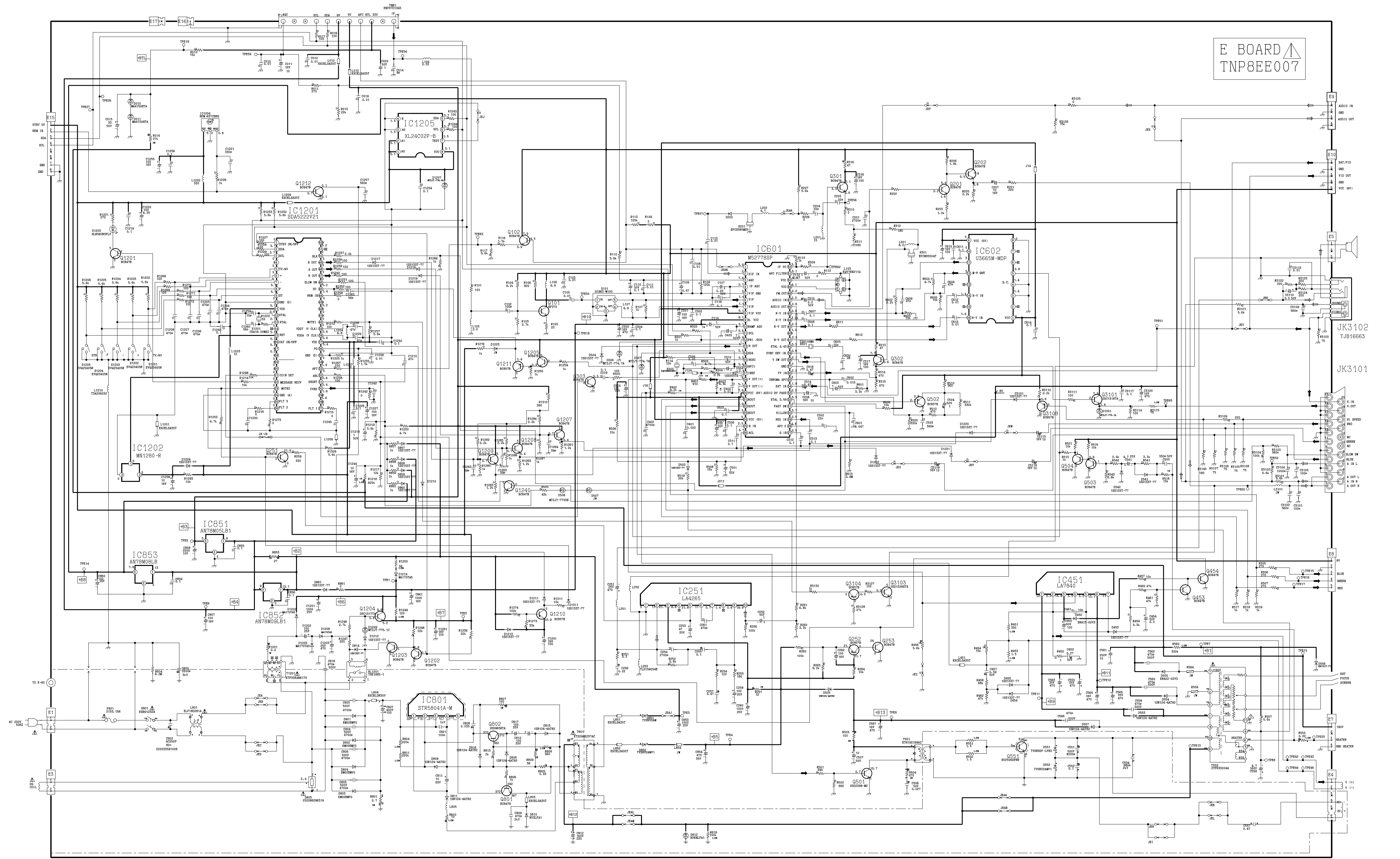

Y BOARD TX - 14S3TC / TC - 14S3RC

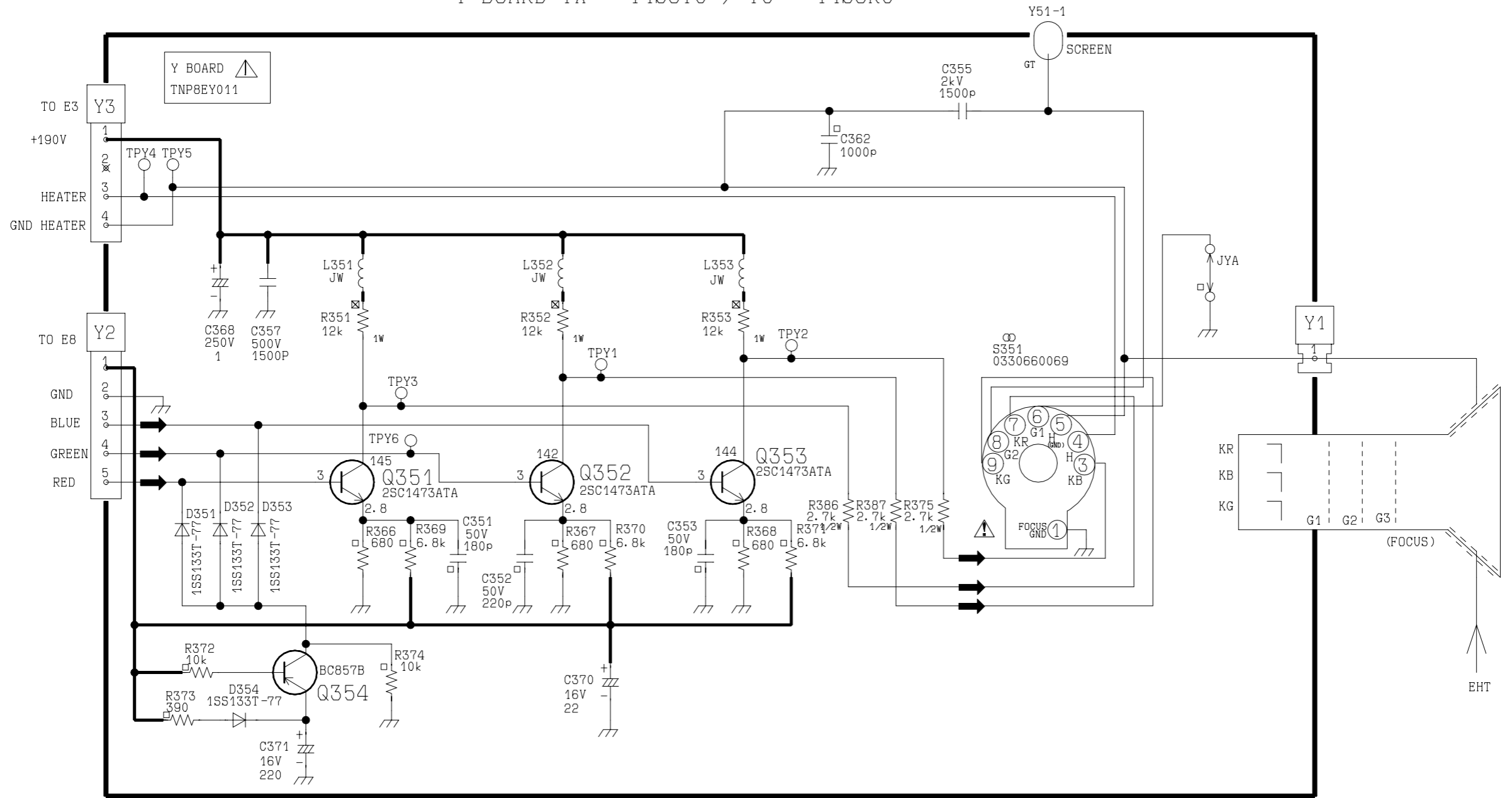

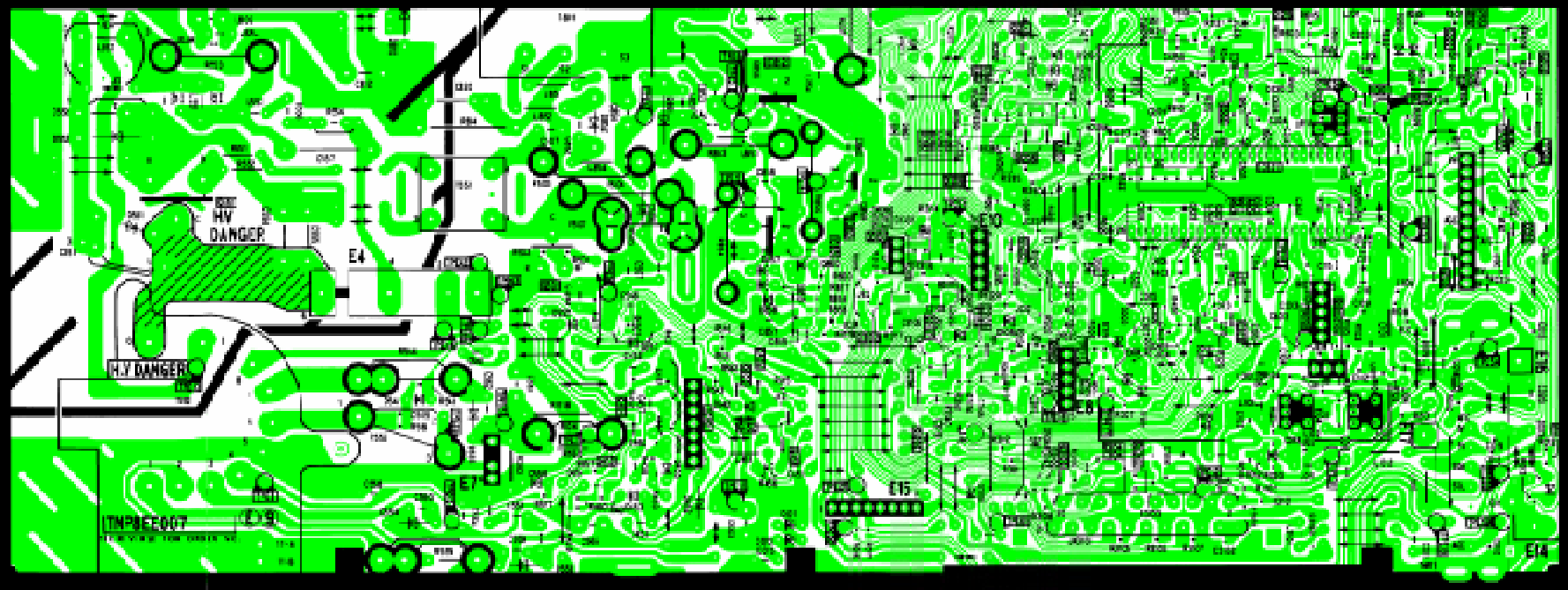
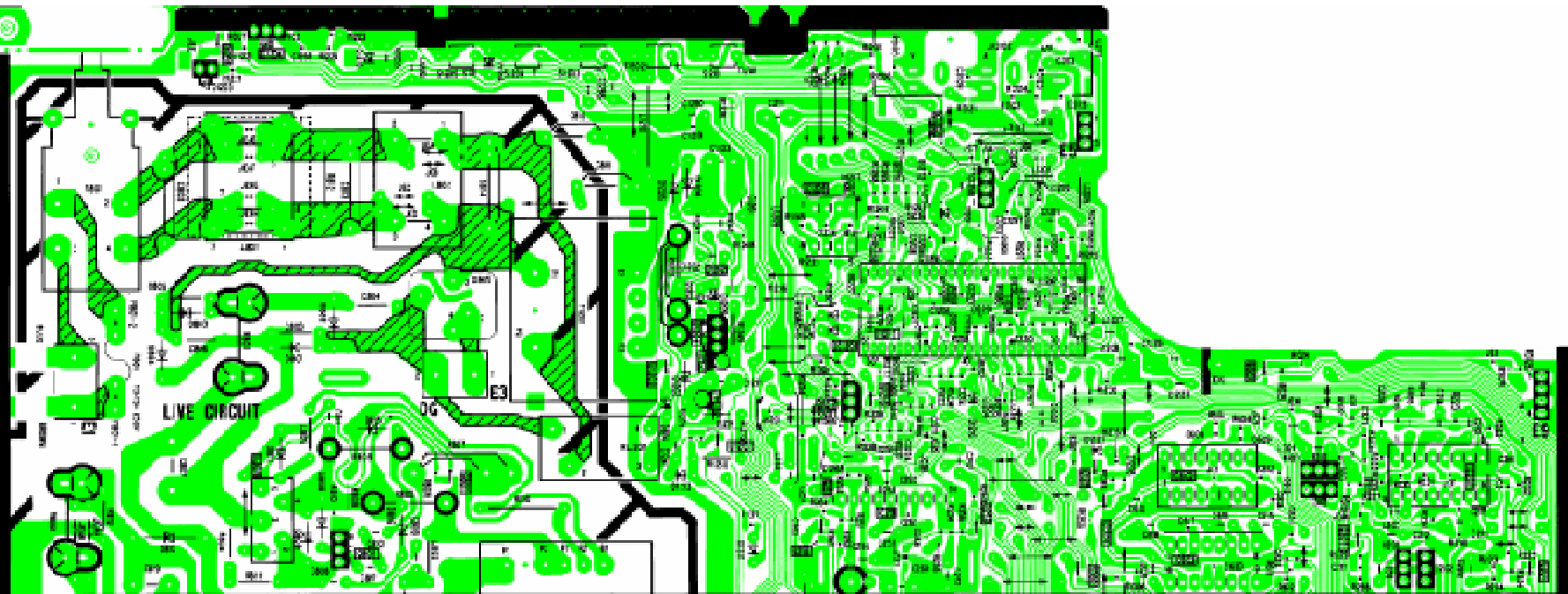

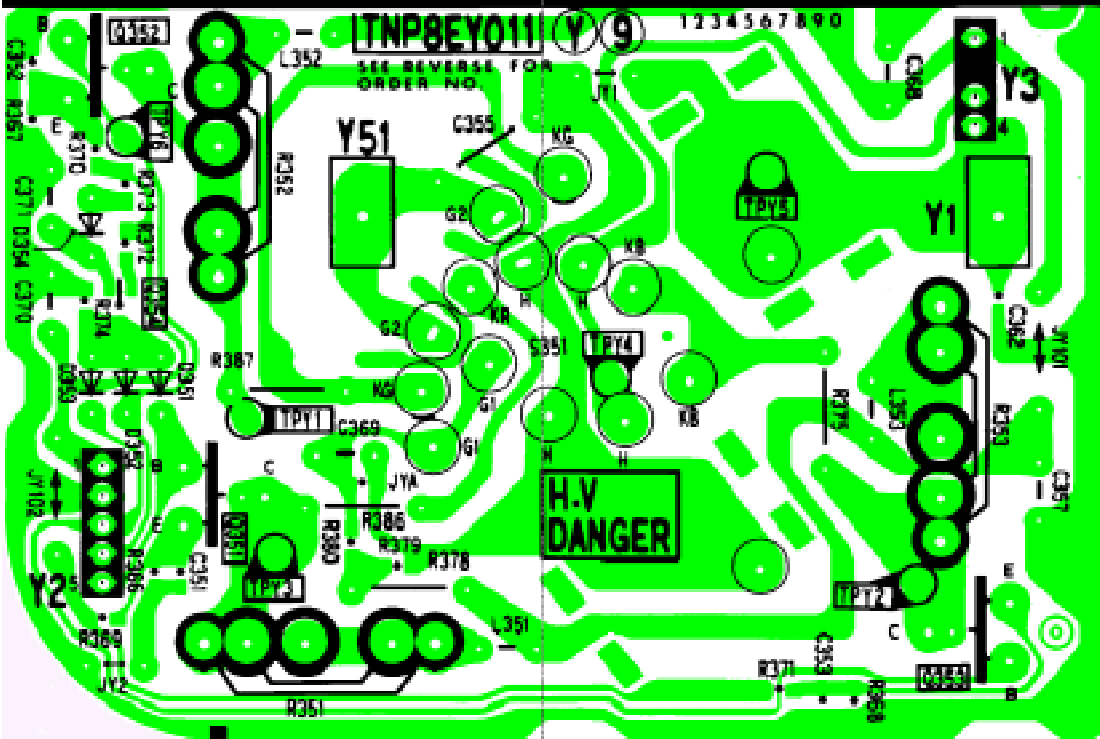

TNP8EY011 Y 9

1234567890

SEE REVERSE FOR ORDER NO.

H.V. DANGER